

HORIBA

Instruction Manual

Benchtop pH/ORP/Ion/DO/BOD Meter

LAQUA-DO2000

LAQUA-PD2000



■ Preface

This manual describes the operation of the following instrument.

| | |
|--------------------|---|
| Brand: | LAQUA |
| Series name: | LAQUA 2000 Series Benchtop Water Quality Meters |
| Model: | LAQUA-DO2000, LAQUA-PD2000 |
| Model description: | pH/ORP/Ion/DO/BOD Benchtop Meter |

Be sure to read this manual before using the product to ensure proper and safe operation of the product. Also, safely store the manual so it is readily available whenever necessary. Product specifications and appearance as well as the contents of this manual are subject to change without notice.

• Warranty and responsibility

HORIBA Advanced Techno Co., Ltd. warrants that the product shall be free from defects in material and workmanship and agrees to repair or replace free of charge, at option of HORIBA Advanced Techno Co., Ltd., any malfunctioned or damaged product attributable to responsibility of HORIBA Advanced Techno Co., Ltd. for a period of three (3) years from the delivery unless otherwise agreed in a written statement. In any one of the following cases, none of the warranties set forth herein shall be extended:

- Any malfunction or damage attributable to improper operation
- Any malfunction attributable to repair or modification by any person not authorized by HORIBA Advanced Techno Co., Ltd.
- Any malfunction or damage attributable to the use in an environment not specified in this manual
- Any malfunction or damage attributable to violation of the instructions in this manual or operations in the manner not specified in this manual
- Any malfunction or damage attributable to any cause or causes beyond the reasonable control of HORIBA Advanced Techno Co., Ltd. such as natural disasters
- Any deterioration in appearance attributable to corrosion, rust and so on
- Replacement of consumables

HORIBA Advanced Techno Co., Ltd. SHALL NOT BE LIABLE FOR ANY DAMAGES RESULTING FROM ANY MALFUNCTIONS OF THE PRODUCT, ANY ERASURE OF DATA, OR ANY OTHER USES OF THE PRODUCT.

• Trademarks

- Microsoft, Windows, Windows Vista are registered trademarks or trademarks of Microsoft Corporation in the United States and other countries.
- Other company names and brand names are either registered trademarks or trademarks of the respective companies. (R), (TM) symbols may be omitted in this manual.

CODE:3200947008 - GZ0000671681
July, 2022 © 2022 HORIBA Advanced Techno Co., Ltd.



Regulations

■ Regulations

• EU and UK Regulations

• Conformable Standards

This equipment conforms to the following standards:



EMC: EN61326-1
Class B, Basic electromagnetic environment
Safety: EN61010-1
RoHS: EN IEC 63000
9. Monitoring and control instruments including industrial monitoring and control instruments



EMC: BS EN 61326-1
Class B, Basic electromagnetic environment
Safety: BS EN 61010-1
RoHS: BS EN IEC 63000
9. Monitoring and control instruments including industrial monitoring and control instruments

Warning: This product is not intended for use in industrial environments. In an industrial environment, electromagnetic environmental effects may cause the incorrect performance of the product in which case the user may be required to take adequate measures.

• Installation Environment:

This product is designed for the following environment.

- Overvoltage category II
- Pollution degree 2
- Maximum operating altitude : 2000 m above sea level
- Range of application : For indoor use

Regulations

• Information on disposal of electrical and electronic equipment and disposal of batteries and accumulators

The crossed out wheeled bin symbol with underbar shown on the product or accompanying documents indicates the product requires appropriate treatment, collection and recycle for waste electrical and electronic equipment (WEEE) under the Directive 2012/19/EU, and/or waste batteries and accumulators under the Directive 2006/66/EC in the European Union. The symbol might be put with one of the chemical symbols below. In this case, it satisfies the requirements of the Directive 2006/66/EC for the object chemical. This product should not be disposed of unsorted household waste. Your correct disposal of WEEE, waste batteries and accumulators will contribute to reducing wasteful consumption of natural resources, and protecting human health and the environment from potential negative effects caused by hazardous substance in products.

Contact your supplier for information on applicable disposal methods.

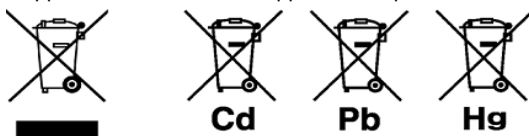

• Authorised Representative in EU

HORIBA Europe GmbH
Hans-Mess-Str.6, D-61440
Oberursel, Germany

• Authorized Representative in UK

HORIBA UK Limited
Kyoto Close Moulton Park
NN3 6FL Northampton, UK
Tel: +44 01604 542500

• FCC Rules

FCC Compliance Statement

This device complies with part 15 of the FCC Rules. Operation is subject to the following two conditions: (1) This device may not cause harmful interference, and (2) this device must accept any interference received, including interference that may cause undesired operation.

Responsible Party for FCC matter

HORIBA Instruments Incorporated
Head Office
9755 Research Drive
Irvine, California 92618 USA
+1 949 250 4811

Regulations

Note

This equipment has been tested and found to comply with the limits for a Class A digital device, pursuant to part 15 of the FCC Rules. These limits are designed to provide reasonable protection against harmful interference when the equipment is operated in a commercial environment. This equipment generates, uses, and can radiate radio frequency energy and, if not installed and used in accordance with the instruction manual, may cause harmful interference to radio communications. Operation of this equipment in a residential area is likely to cause harmful interference in which case the user will be required to correct the interference at his own expense.

Any changes or modifications not expressly approved by the party responsible for compliance could void the user's authority to operate the equipment.

• Korea certification

B급 기기 (가정용 방송통신기자재)

이 기기는 가정용(B 급) 전자파적합기기로서 주로 가정에서 사용하는 것을 목적으로 하며, 모든 지역에서 사용할 수 있습니다.

• China regulation

标记的意义

Meaning of Marking



本标记适用在中华人民共和国销售电器电子产品，标记中央的数字表示环境保护使用期限的年数。（不是表示产品质量保证期间。）只要遵守这个产品有关的安全和使用注意事项，从制造日开始算起在这个年限内，不会给环境污染、人体和财产带来严重的影响。请不要随意废弃本电器电子产品。

This marking is applied to electric and electronic products sold in the People's Republic of China. The figure at the center of the marking indicates the environmental protection use period in years. (It does not indicate a product guarantee period.) It guarantees that the product will not cause environment pollution nor serious influence on human body and property within the period of the indicated years which is counted from the date of manufacture as far as the safety and usage precautions for the product are observed. Do not throw away this product without any good reason.

产品中有害物质的名称及含量

Regulations

Name and amount of hazardous substance used in a product

| 部件名称 Unit name | 有害物质 Hazardous substances | | | | | |
|---------------------------------------|------------------------------|---------------------------|---------------------------|---|---|--|
| | 铅 Lead (Pb) | 汞 Mer- cury (Hg) | 镉 Cad- mium (Cd) | 六价铬 Hexa- valent chromium (Cr (VI)) | 多溴联苯 Poly bromobi- phenyl (PBB) | 多溴二苯醚 Poly bromo- diphenyl ether (PBDE) |
| 本体 Main unit | × | ○ | ○ | ○ | ○ | ○ |
| AC 适配器 AC adapter ^{*1,*2} | × | ○ | ○ | ○ | ○ | ○ |
| 电缆 Cable ^{*2} | × | ○ | ○ | ○ | ○ | ○ |
| 支架 Stand ^{*2} | ○ | ○ | ○ | ○ | ○ | ○ |
| 打印机 Printer ^{*2} | × | ○ | ○ | ○ | ○ | ○ |
| 电极 Electrode ^{*2} | × | ○ | × | ○ | ○ | ○ |

本表格依据 SJ/T 11364 的规定编制。

This form is prepared in accordance with SJ/T 11364.

○：表示该有害物质在该部件所有均质材料中的含量均在 GB/T 26572 规定的限量要求以下。

Denotes that the amount of the hazardous substance contained in all of the homogeneous materials used in the component is below the limit on the acceptable amount stipulated in the GB/T 26572.

×：表示该有害物质至少在该部件的某一均质材料中的含量超出 GB/T 26572 规定的限量要求。

Denotes that the amount of the hazardous substance contained in any of the homogeneous materials used in the component is above the limit on the acceptable amount stipulated in the GB/T 26572.

*1: 本部件的环保使用期限为10年。 The environmental protection use period of this product is 10 years.

*2: 选配件 Optional products

For Your Safety

■ For Your Safety

• Hazard classification and warning symbols

Warning messages are described in the following manner. Read the messages and follow the instructions carefully.

• Hazard classification



This indicates an imminently hazardous situation which, if not avoided, will result in death or serious injury. This is to be limited to the most extreme situations.



This indicates a potentially hazardous situation which, if not avoided, could result in death or serious injury.



This indicates a potentially hazardous situation which, if not avoided, may result in minor or moderate injury. It may also be used to alert against unsafe practices.

• Warning symbols



Description of what should be done, or what should be followed.



Description of what should never be done, or what is prohibited.

For Your Safety

• [DEU] Sicherheitsinformation

Lesen Sie vor der Verwendung des Produkts unbedingt diese Anleitung, um den ordnungsgemäßen und sicheren Betrieb des Produkts zu gewährleisten. Bewahren Sie die Anleitung sicher auf, damit sie bei Bedarf jederzeit zur Hand ist. Die Inhalt dieser Anleitung können ohne Vorankündigung geändert werden.

• Installationsumgebung

Dieses Produkt ist nicht zum Gebrauch in industriellen Umgebungen, wie in EN61326-1 definiert, vorgesehen.

In einer industriellen Umgebung können die elektromagnetischen Störungen eventuell zu Produktfehlfunktionen führen. Um dieses Produkt unter solchen Umständen verwenden zu können, muss der Benutzer ggf. angemessene Maßnahmen ergreifen.

Das Produkt ist gemäß EN61010-1 für die folgende Umgebung vorgesehen.

- Überspannungskategorie II
- Verschmutzungsgrad 2

• [FRA] Informations de sécurité

Veillez à lire le présent manuel avant d'utiliser le produit de manière à garantir son utilisation correcte et sûre.

De même, rangez le manuel dans un lieu sûr de manière à pouvoir vous y reporter lorsque cela est nécessaire.

Le contenu du présent manuel peut être modifié sans notification préalable.

• Environnement d'installation

Ce produit n'est pas destinés à une utilisation dans des environnements industriels, tels que définis dans la norme EN61326-1.

Dans un environnement industriel, les interférences électromagnétiques peuvent entraîner un dysfonctionnement du produit. Pour utiliser le produit dans ce type d'environnements, l'utilisateur peut avoir à prendre des mesures appropriées.

Le produit est conçu pour l'environnement suivant, tel que défini dans la norme EN61010-1.

- Catégorie de surtension II
- Degré de pollution 2

• [ITA] Informazioni sulla sicurezza

Leggere attentamente questo manuale prima di utilizzare il prodotto al fine di utilizzarlo in modo sicuro e adeguato. Inoltre, conservare in un luogo sicuro il manuale per poterlo consultare se necessario.

Le contenuti di questo manuale sono soggetti a modifiche senza preavviso.

For Your Safety

• Ambiente di installazione

Questo prodotto non è stato progettato per essere utilizzato in ambienti industriali, secondo la norma EN61326-1.

In un ambiente industriale, le interferenze elettromagnetiche potrebbero causare un malfunzionamento del prodotto. Per utilizzare il prodotto in tali ambienti, all'utente potrebbe essere richiesto di adottare le contromisure necessarie.

Il prodotto è designato per il seguente ambiente, definito nello standard EN61010-1.

- Categoria di sovratensione II
- Livello di inquinamento 2

• [SWE] Säkerhetsinformation

Se till att du läser denna handbok innan du börjar använda produkten för en korrekt och säker användning av den. Spara sedan handboken på en säker och lättåtkomlig plats så att du kan konsultera den när så behövs.

Innehållet i denna handbok kan komma att ändras utan föregående meddelande därom.

• Installationsmiljö

Detta produkten är ej avsedda för användning i industriella miljöer enligt riktlinjerna i EN61326-1.

Om den används i industrimiljöer kan de elektromagnetiska störningarna orsaka tekniska fel hos produkten. Om produkten ska användas i sådana miljöer kan användaren behöva vidta lämpliga åtgärder för att lösa dessa problem.

Produkten är utformad för användning i följande miljöer, i enlighet med SS-EN 61010-1.

- Överspänningskategori II
- Föroreningsgrad 2

• [SPA] Información de seguridad

Asegúrese de leer este manual antes de utilizar el producto para garantizar un uso correcto y seguro del mismo. Asimismo, guarde de forma segura el manual para que esté disponible siempre que sea necesario.

El contenido de este manual están sujetos a cambios sin previo aviso.

• Entorno de instalación

Este producto está diseñado para su uso en entornos industriales, tal y como se define en EN61326-1.

En un entorno industrial, las interferencias electromagnéticas pueden provocar un funcionamiento

incorrecto del producto. Para usar el producto en tales entornos, el usuario debe tomar las medidas adecuadas.

El producto se ha diseñado para el siguiente entorno, definido en EN61010-1.

- Categoría de sobretensión II
- Nivel de contaminación 2

For Your Safety

• [POL] Informacje dotyczące bezpieczeństwa

Przed przystąpieniem do użytkowania tego produktu należy dokładnie zapoznać się z niniejszą instrukcją, aby zapewniona była prawidłowa i bezpieczna eksploatacja produktu. Instrukcję przechowywać w bezpiecznym miejscu, aby w razie potrzeby była zawsze dostępna.

Treść niniejszej instrukcji może ulec zmianie bez wcześniejszego powiadomienia.

• Środowisko instalacji

Ten produkt nie są przeznaczone do użytkowania w środowisku przemysłowym, zgodnie z definicją określoną w normie EN61326-1.

W środowisku przemysłowym zakłócenia elektromagnetyczne mogą powodować nieprawidłowe działanie produktów. Możliwe, że aby użytkować produkt w takich środowiskach, użytkownik będzie musiał podjąć stosowne środki zaradcze.

Produkt jest przeznaczony do użycia w poniższym środowisku zdefiniowanym w normie EN61010-1.

- Kategoria przepięciowa II
- Stopień zanieczyszczenia 2

• [NLD] Veiligheidsinformatie

Lees deze handleiding voordat u dit product gebruikt zodat u het op de juiste manier en veilig kunt gebruiken. Bewaar de handleiding goed zodat u hem wanneer nodig kunt raadplegen.

De inhoud van deze handleiding kunnen zonder voorafgaande kennisgeving worden gewijzigd.

• Installatieomgeving

Dit product is niet bedoeld voor gebruik in een industriële omgeving zoals gedefinieerd in EN 61326-1.

In een industriële omgeving kan de elektromagnetische interferentie de werking van dit product storen. Voor gebruik van het product in een dergelijke omgeving moet de gebruiker mogelijk maatregelen treffen om de storing te verhelpen.

Het product is ontworpen voor de volgende omgeving, gedefinieerd in EN 61010-1.

- Overspanningscategorie II
- Vervuilingsgraad 2

• [JPN] 安全情報

ご使用になる前に、本書を必ずお読みください。お読みになった後は必要なときにすぐに取り出せるように大切に保管してください。

本書に記載されている内容は予告なく変更される場合があります。あらかじめご了承ください。

・設置環境

本製品は、EN61326-1 で定義される工業環境で使用することを想定した製品ではありません。

工業環境においては、電磁妨害の影響を受ける可能性があり、その場合には使用者が適切な対策を講ずることが必要となることがあります。

本製品は、EN61010-1 で定義される以下の環境用に設計されています。

- 過電圧カテゴリー II
- 汚染度 2

For Your Safety

• Safety precautions

This section provides precautions for using the product safely and correctly and to prevent injury and damage. The terms of DANGER, WARNING and CAUTION indicate the degree of immanency and hazardous situation. Read the precautions carefully as it contains important safety messages.

• Instrument and electrode



WARNING



Do not disassemble or modify the instrument. Otherwise, it may heat up or be ignited resulting in a fire or an accident.



CAUTION

Harmful chemicals

Some electrodes are used with hazardous standard solutions. Handle them with care. The internal solution of pH electrode is highly concentrated potassium chloride (3.33 mol/L KCl). If the internal solution comes in contact with the skin, wash it off immediately. If it gets into the eyes, flush with plenty of water and then consult a doctor.



Broken glass

Broken glass may cause injury. The outer tube and tip of an electrode are made of glass. Handle them with care.



Do not use the phono jack under wet or humid conditions. Otherwise, it may cause a fire, electric shock, or breakage.

Product Handling Information

■ Product Handling Information

• Operational Precautions (instrument)

- Only use the product including accessories for their intended purpose.
- Do not drop or physically impact the instrument.
- The instrument is made of solvent-resistant materials but that does not mean it is resistant to all chemicals. Do not expose the instrument in strong acid or alkali solution, or wipe with such solution.
- If the instrument is dropped into water or gets wet, wipe it using soft cloth. Do not heat to dry it.
- Use fingers to press the operation keys. Do not use a hard object like a metal stick or rod.
- Be careful not to let water inside the instrument. The instrument is not waterproof.
- To disconnect an electrode or serial cable, hold the connector and pull it off. If you pull at the cable, it may cause breakage.
- The phono jack communication between the instrument and a personal computer (referred to as PC in the rest of this document) may fail because of environmental conditions, such as electromagnetic noise.
- Do not use an object with a sharp end to press the keys.
- If the power supply is interrupted while measurement data is being saved in the instrument, the data could be corrupted.
- Make sure to use the provided power supply cable to power this product.

• Environmental conditions for use and storage

- Temperature: 0°C to 45°C
- Humidity: under 80% relative humidity and free from condensation

• Avoid the following conditions:

- Strong vibration
- Direct sunlight
- Corrosive gas environment
- Locations close to an air-conditioner
- Direct wind
- Dusty Environment

• Transportation

When transporting the instrument, repackage it in the original package box. Otherwise, it may cause instrument damage.

• Disposal

- Standard solution used for the calibration must be under neutralized before the disposal.
- When disposing of the product, follow the related laws and regulations of your country for disposal of the product.

Manual Information

■ Manual Information

- Description in this manual

Note

This interprets the necessary points for correct operation and notifies the important points for handling the product.

Tip

This indicates reference information.

Table of Contents

| | |
|---|----|
| ■ Product Overview | 1 |
| ● Package Content | 1 |
| ● Key Features | 2 |
| ■ Basic Operations | 6 |
| ● Turning On the Instrument | 6 |
| ● Connecting an Electrode | 6 |
| ● Changing the Operation Mode | 7 |
| ● Changing the Measurement Parameter..... | 9 |
| ■ Calibration..... | 10 |
| ● pH Calibration..... | 10 |
| ● ORP/mV Calibration | 13 |
| ● Ion Calibration | 15 |
| ● DO Calibration | 18 |
| ● Temperature Calibration..... | 23 |
| ■ BOD Measurement | 25 |
| ■ Data | 27 |
| ● Data Capture and Storage | 27 |
| ● Data Transfer | 28 |

Table of Contents

| | |
|---|----|
| ■ Setup | 29 |
| ● P1 pH Setup | 29 |
| ● P1 Ion Setup | 34 |
| ● P1 DO Setup | 39 |
| ● P2 Data Setup | 46 |
| ● P3 General Setup | 50 |
| ● P4 Clock Setup | 56 |
| ■ Maintenance and Storage | 59 |
| ● Contact for Maintenance | 59 |
| ● Maintenance and Storage of the Instrument | 59 |
| ● Maintenance and Storage of Electrodes | 60 |
| ■ Error Messages and Troubleshooting | 63 |
| ■ Appendix | 68 |

■ Product Overview

The LAQUA-DO2000 and LAQUA-PD2000 benchtop meters are optimized for laboratory measurement. The LAQUA-DO2000 benchtop meter allows you to measure dissolved oxygen (DO), biochemical oxygen demand (BOD), and temperature while LAQUA-PD2000 benchtop meter allows you to measure pH, ORP/mV, ion, DO, BOD, and temperature.

This section describes the package content, key features and product components of LAQUA-DO2000 and LAQUA-PD2000 benchtop meters.

● Package Content

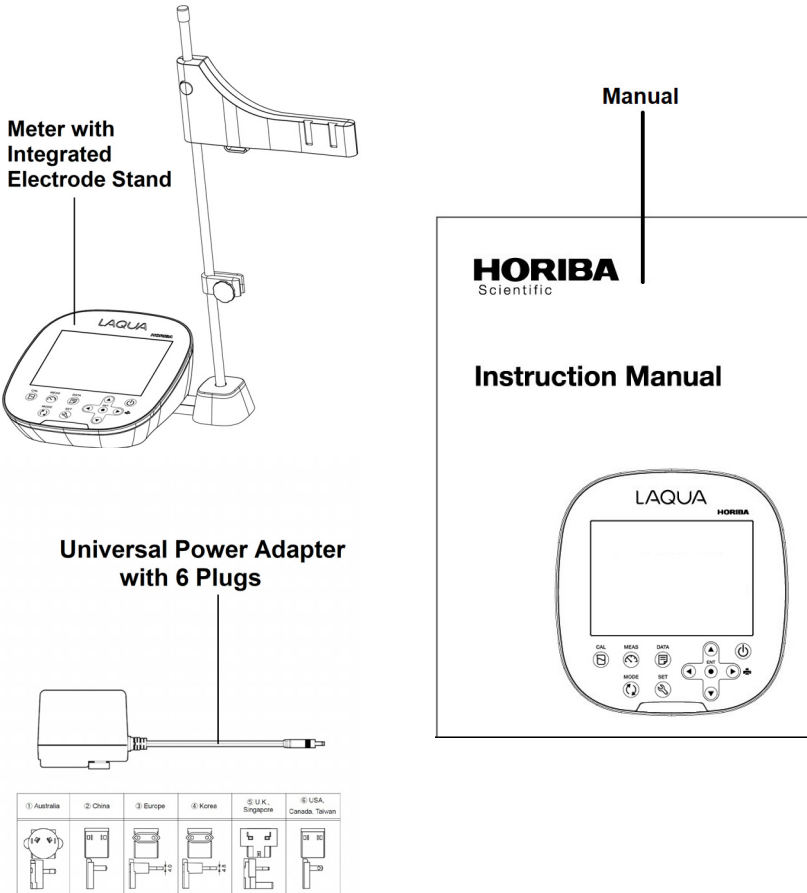

After opening the package, check for damage on the instrument and the standard accessories all exist. If damage or defects are found on the product, contact your dealer.

● Key Features

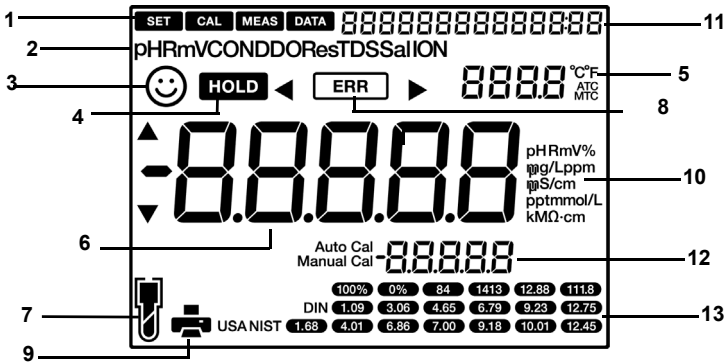

- Large monochrome LCD
- Integrated electrode holder (up to 2 electrodes) that can be attached to either side of the meter
- Simple user interface and single parameter display
- 2000 Memory data
- Real time clock
- Automatic Temperature Compensation (ATC) with temperature calibration
- Adjustable auto shut-off time (1 to 30 minutes)
- Auto stable, auto hold, and real time measurement modes with reading stability indicators
- PC (standard USB) / printer (25 pin serial) connection via 2.5 mm diameter phono jack
- Adjustable calibration alarm (1 to 90 days)
- Auto data log with date and time stamp
- Software upgrade
- Password protection for setup mode

• Display





| No | Name | Function |
|----|--|---|
| 1 | Status Icon | Displays the current operation mode (Setup, Calibration, Measurement and Data mode) |
| 2 | Parameters | Displays the measured parameters like pH, mV, ION, DO |
| 3 | | Smiley icon and sound indicate value is stable for documentation in Auto Stable and Auto Hold modes |
| 4 | HOLD | Appears when the measured value display is stable and fixed in Auto Hold mode |
| 5 | Temperature Display Area | Displays the measured temperature, temperature unit, and ATC/MTC. |
| 6 | Measured Value, Set Item Display Area | Displays the measured value and the set value |
| 7 | | Indicates electrode sensitivity level |
| 8 | ERR | Indicates error situation |
| 9 | | Indicates data being transferred to the printer or computer |
| 10 | pH RmV% mg/Lppm µS/cm ppt kMΩ·cm | Displays the unit for the measurement parameter |
| 11 | 8888888888888888 | Displays date and time |

Product Overview

| No | Name | Function |
|----|--|--|
| 12 | Auto Cal Manual Cal  | Displays the calibration method |
| 13 |  | Displays the pH buffer groups, pH buffer auto calibration values, and DO auto calibration values |

● Electrode Sensitivity Level

| Electrode Icon | | pH Average Slope | Ion Average Slope | DO Span Coefficient |
|---|-----------|------------------|-------------------|---------------------|
|  | Excellent | 95.0 to 105.0% | 90.1 to 199.9% | 0.670 to 1.300 |
|  | Very Good | 85.0 to 94.9% | 85.1 to 90.0% | 1.301 to 1.667 |
|  | Good | 80.0 to 84.9% | 50.1 to 85% | 1.668 to 2.000 |

If "SLPE ERR" appears, refer to page 63.

• Keypad Operation

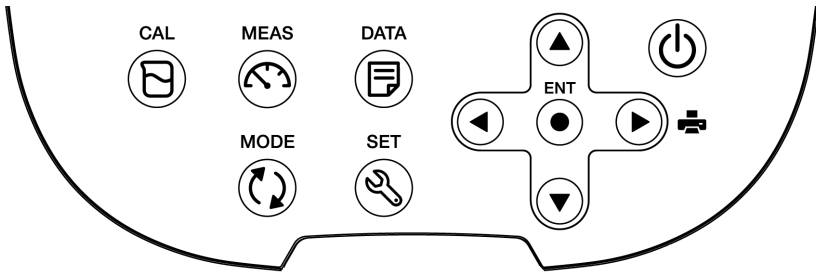

| Keypad | Name | Function |
|--------|-----------|---|
| | CAL key | Switches from the measurement mode to the calibration mode. Starts calibration in the calibration mode. |
| | MEAS key | Switches from the operation mode to the measurement mode. Releases the fixed measurement value mode in the auto hold mode and begins a fresh measurement. |
| | DATA key | Switches from the measurement mode to the data mode. |
| | MODE key | In the measurement mode, changes measurement parameters. |
| | SET key | Switches from the measurement mode to the setup mode. |
| | ENTER key | Determines the selection or setup. Saves data in the measurement mode and calibration mode. |
| | UP key | Navigates between various settings in setup mode. Increases or decreases selected digit when entering numbers. |
| | DOWN key | |
| | RIGHT key | Navigates between digit positions when entering numbers. |
| | LEFT key | Prints out the measurement values (key). |
| | POWER key | Powers ON/OFF the instrument. |

■ Basic Operations

This section describes the basic operations such as turning on the instrument, connecting an electrode, and changing the operation modes and measurement parameters of LAQUA-DO2000 and LAQUA-PD2000 benchtop meters.

● Turning On the Instrument

1. Insert the AC adapter cable by fitting with the AC adapter jack.
2. Insert the AC adapter into the electrical socket.
3. Press the POWER key of the meter.

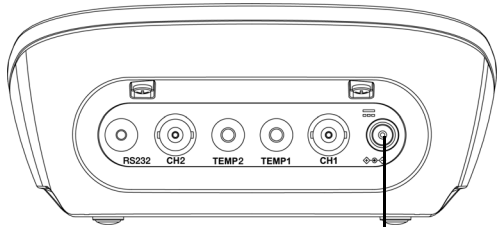

AC Adapter jack

● Connecting an Electrode

To perform calibration / measurement, it is necessary to use the appropriate electrode for measurement parameter. Use the following procedure to correctly connect pH/ORP/Ion electrode to channel 1 (CH1) and DO electrode to channel 2 (CH2) of the instrument:

1. Insert the electrode connector by fitting its groove with the connector pin of the instrument.
2. Turn the electrode connector clockwise by following the grooves.
3. Slide the connector cover on the connector.
4. When using a combination electrode equipped with a temperature sensor, insert the temperature jack (T) to the ATC socket on the meter.

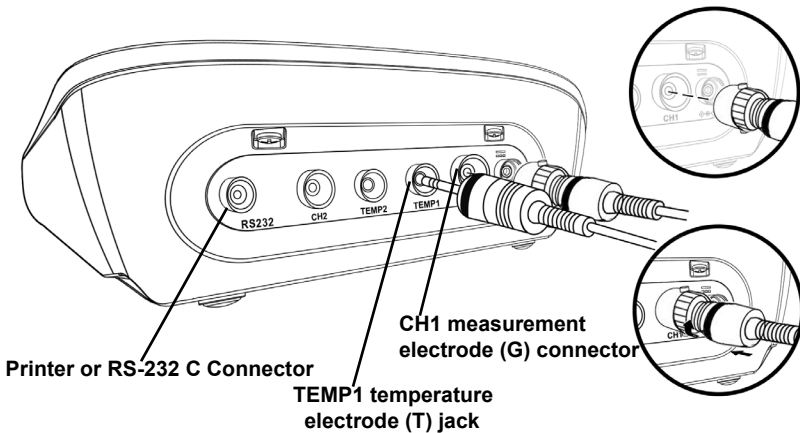

Printer or RS-232 C Connector

TEMP1 temperature electrode (T) jack

● Changing the Operation Mode

You can change the operation mode to four available modes depending on the purpose of use. The status icon indicates the current mode.

Status icon

SET

CAL





MEAS

DATA

| Icon | Name | Function |
|-------------|------------------|---|
| MEAS | Measurement mode | Performs measurement. |
| CAL | Calibration mode | Performs calibration. |
| DATA | Data mode | Displays the saved data. |
| SET | Setup mode | Perform various setups for different functions. |

Basic Operations

You can change the operation mode using the corresponding key:

- **Measurement mode:** Press the  key to change to the measurement mode.
- **Calibration mode:** In the measurement mode, press the  key to change to the calibration mode.
- **Data mode:** In the measurement mode, press the  key to change to the data mode.
- **Setup mode:** In the measurement mode, press the  key to change to the setup mode.

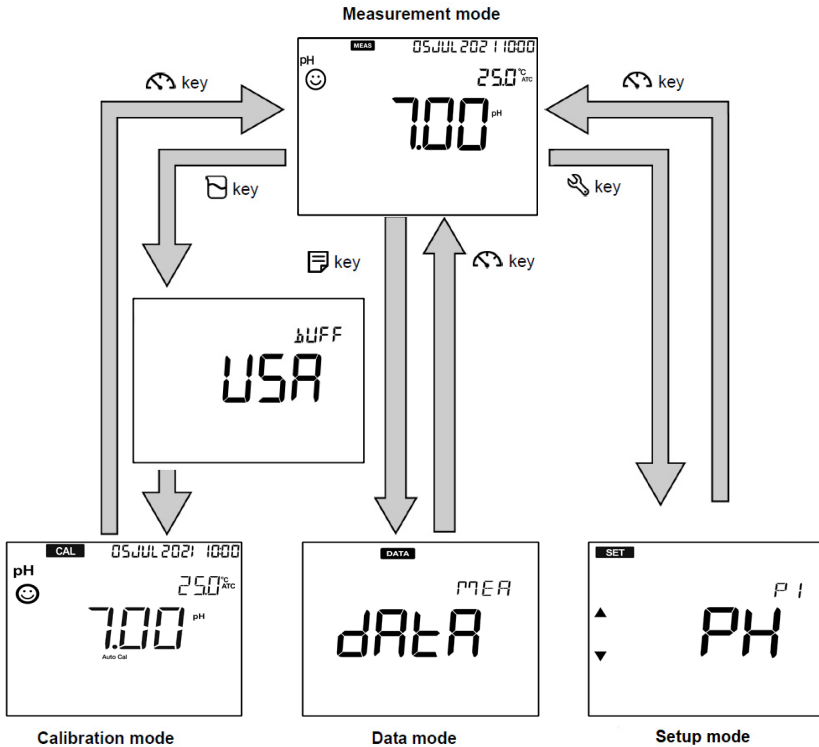

● Changing the Measurement Parameter

The LAQUA-PD2000 benchtop meter measures pH, ORP/mV, ion, dissolved oxygen (DO), and biochemical oxygen demand (BOD) while the LAQUA-DO2000 benchtop meter measures DO and BOD. For measurement, an electrode corresponding to the measurement parameter is required. In the measurement mode, the measurement parameter can be changed by pressing the  key.

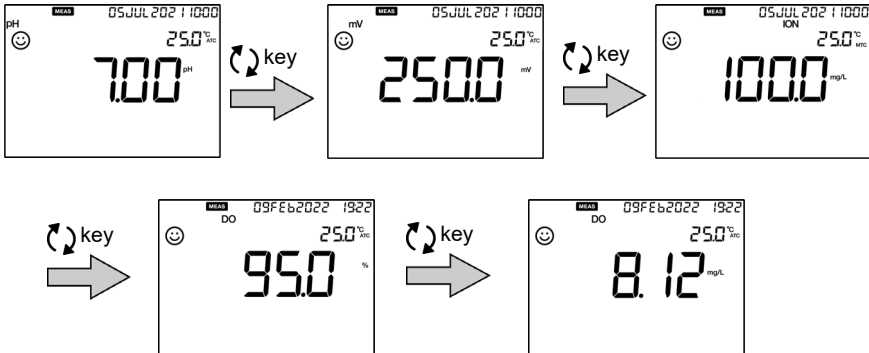

| Model | Measurement Parameters |
|--------|--------------------------|
| DO2000 | DO, BOD |
| PD2000 | pH, ORP/mV, Ion, DO, BOD |

■ Calibration

This section describes the calibration procedures using the LAQUA-DO2000 and LAQUA-PD2000 benchtop meters and electrodes.

● pH Calibration

Calibration is necessary for accurate pH measurement. To perform pH calibration using LAQUA-PD2000 benchtop meter, follow the procedure detailed below:

Prerequisites

- Clean the pH electrode with DI (deionized) water and wipe it with tissue paper.
- Switch on the meter and plug in the pH electrode.
- Prepare the pH buffers required for calibration.
- Keep the meter in pH measurement mode.
- Dip the pH electrode at least 3 cm in the pH buffer.





Note

- Perform two-point calibration using:
pH 7 and 4 for acidic sample.
pH 7 and 10 for alkaline sample.
- Perform three-point calibration using pH 7, 4 and 10 if you are unsure of the expected sample pH value. It is recommended to calibrate with pH 7 first.
- Default pH buffer group in buffer setup is **USA**. If you want to change to **NIST**, **NIST2**, **DIN**, or **CUST** (Custom) refer to “P1.1 Buffer Setup” on page 30.
- For **USA**, **NIST**, **NIST2**, and **DIN** pH buffer groups, follow the Auto Calibration procedure. For **CUST**, follow Manual Calibration procedure.

Tip

- To abort an ongoing calibration process at any point of time, press the  key.
 - It is recommended to clear the previous calibration data before performing calibration. For erasing the calibration data, refer to “P1.4 Calibration Clear Setup” on page 33.
-

Auto Calibration



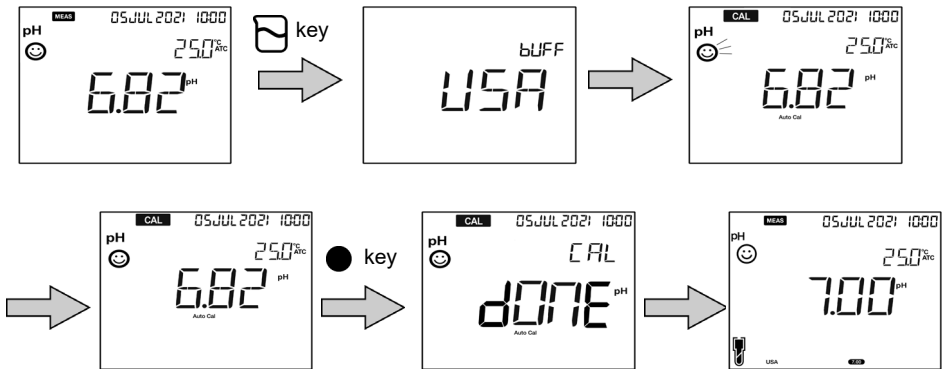



1. After placing the pH electrode in pH buffer, press the **CAL**  key.
2. The selected pH buffer group (USA, NIST, NIST2 or DIN) appears on the meter screen and meter starts checking various calibration values with a blinking  on screen.
3. Wait for the  to stabilize. When it stabilizes, there will be a sound indicating that reading is stable.
4. Press the **ENT**  key to confirm and save calibration data.
5. Meter displays **CAL DONE** indicating end of the pH calibration procedure. Electrode icon, pH buffer group, and calibrated pH buffer icon light up in measurement mode.
6. Repeat above steps for other calibration points as required.



Note

To view and/or print calibration data, press the  key when you are in the **CAL** mode. The display scrolls through the calibrated values, segment slope(s), average slope, and offset.

Manual Calibration

1. After placing the pH electrode in pH buffer, press the **CAL**  key.
2. The selected **CUST** pH buffer group appears on the meter screen.
3. Wait for the  to stabilize. When it stabilizes, there will be a sound indicating that reading is stable.
4. Press   and   arrows to enter the pH buffer value.
5. Press the **ENT**  key to confirm and save calibration data.
6. Meter displays **CAL DONE** indicating end of the pH calibration procedure. Electrode icon and number of calibration points done (e.g. 1 PT for 1 point, 2 PTS for 2 points) light up in measurement mode.
7. Repeat above steps for other calibration points as required.

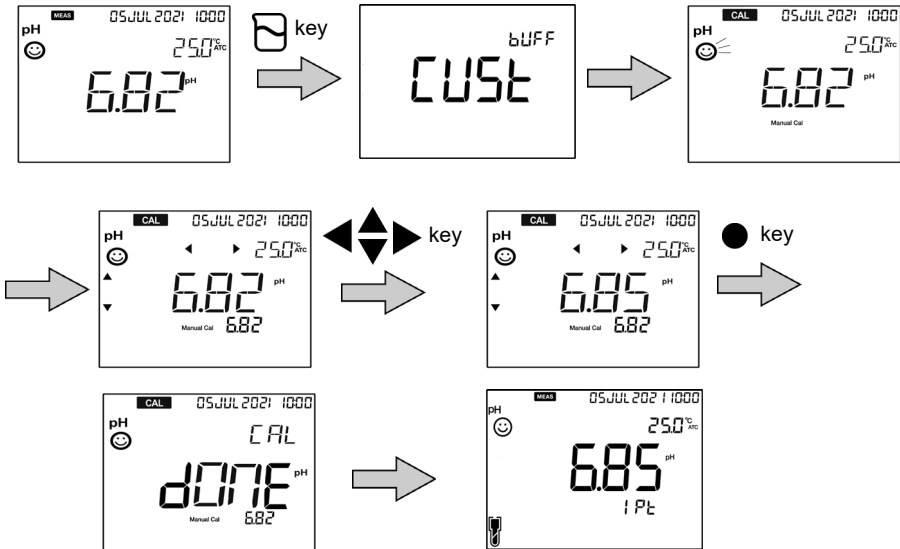

Note

To view and/or print calibration data, press the  key when you are in the **CAL** mode. The display scrolls through the calibrated values, segment slope(s), average slope, and offset.

● ORP/mV Calibration

Calibration is necessary for accurate ORP measurement. To perform ORP calibration using LAQUA-PD2000 benchtop meter, follow the procedure detailed below:

Prerequisites

- Clean the ORP electrode with DI (deionized) water and wipe it with tissue paper.
- Switch on the meter and plug in the ORP electrode.
- Prepare standard solution required for calibration.
- Ensure that the meter is in mV measurement mode.
- Dip the ORP electrode into the standard solution ensuring that the solution level is at least 3 cm from the electrode tip.







Note

- Absolute value measurement mode and relative value measurement mode are the two types of measurement mode available for ORP (mV) measurement.
 - In absolute value measurement mode, the benchtop meter displays the actual voltage value.
 - In relative value measurement mode, user can adjust the absolute mV value by calibration. If the mV value is adjusted, the meter automatically indicates relative mV value as **RmV**. The adjustment mV is applied as an offset to the absolute mV value.
 - In the relative mV mode, the absolute mV value can be adjusted by ± 200 mV.
-

Tip

To abort an ongoing calibration process at any point of time, press the  key.

Calibration

1. After placing the ORP electrode in ORP standard solution, press the  key to switch to mV mode.
2. Press the  key.
3. Meter starts reading mV values.
4. Wait for the  to stabilize. When it stabilizes, there will be a sound indicating that reading is stable.
5. Use the  and  keys to adjust the mV value to the ORP standard solution value.
6. Press the **ENT**  key to confirm and save calibration data.
7. Meter displays **CAL DONE** indicating end of the ORP/mV calibration procedure. mV changes to RmV in measurement mode.

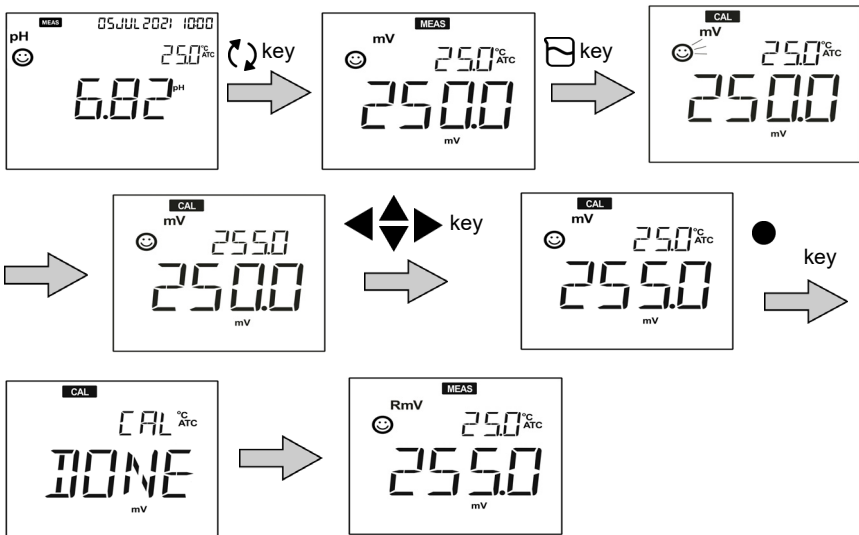

• Ion Calibration

Calibration is necessary for accurate ion measurement. To perform ion calibration using LAQUA-PD2000, follow the procedure detailed below:

Prerequisites

- If ion electrode is new or stored for long period, condition it first. Refer to the ion electrode manual for the electrode preparation and conditioning procedures.
- Clean the ion electrode with DI (deionized) water and wipe it with tissue paper.
- Switch on the meter and plug in the ion electrode.
- Ensure that the meter is in ion measurement mode.
- Select the ion electrode in use (or set the ion valence) and concentration unit of standard solutions in ion setup mode.
- Prepare standard solutions required for calibration. Refer to the ion electrode manual for the standard solution preparation procedure.
- Dip the ion electrode into the standard solution ensuring that the solution level is at least 3 cm from the electrode tip.









Note

- For calibration, prepare at least 2 standards solutions with ionic strength adjustor that are ten-fold apart in concentration.
- Standard solutions should bracket the expected ion concentration in the sample.
- For setting the ion concentration unit, refer to “P1.1 Ion Concentration Unit Setup” on page 35. Three units are available: $\mu\text{g/L} \leftrightarrow \text{mg/L} \leftrightarrow \text{g/L}$, $\text{ppm} \leftrightarrow \text{ppt}$ and $\text{mmol/L} \leftrightarrow \text{mol/L}$.
- For selecting the ion electrode type or setting the valence of the ion to be measured refer to “P1.2 Ion Electrode Type Setup” on page 36. Seven ion electrode types are available: **NH3** (Ammonia), **CL** (Chloride), **FL** (Fluoride), **NO3** (Nitrate), **POT** (Potassium), **CA** (Calcium) and **CUST** (Custom).
- Select **CUST** and then the correct ion valence (-2, -1, 1, 2), if the ion electrode in use is not in the selection of ion electrode types. Ion valence is **CHRG** in the meter, which stands for “charge”.
- Ion concentration varies depending on the sample temperature. For accurate measurement, it is recommended that the calibration and measurement are carried out at a constant temperature (e.g., using a constant temperature bath). Stir the standard solutions and samples using a stirrer during calibration and measurement.
- Because the ion electrode is not equipped with a temperature sensor, the temperature electrode must be connected in order to use the automatic temperature compensation (ATC). In ATC mode, the Nernst slope (mV/one decade) is automatically changed corresponding to the measured temperature by the temperature sensor. If the ATC function is not used, match the temperature setting of the instrument to the temperature of the standard solutions during calibration and match the sample temperature to the temperature setting of the instrument in measurement. By doing so, you can obtain the correct measurement value without being affected by sensitivity variation caused by temperature.

Tip

- To abort an ongoing calibration process at any point of time, press the  key.
 - It is recommended to clear the previous calibration data before performing calibration. For erasing the calibration data, refer to "P1.3 Calibration Clear Setup" on page 38.
-

Calibration

1. After placing the ion electrode in standard solution, press the  key.
2. Wait for  to stabilize. When it stabilizes, there will be a sound indicating that reading is stable.
3. Press   and   keys to enter the standard solution concentration and adjust the unit. Press the  key to adjust the decimal point location.
4. Press the **ENT**  key to confirm and save calibration data.
5. Meter displays **CAL DONE** indicating end of the ion calibration procedure. Electrode icon and number of calibration points done (e.g. 1 PT for 1 point, 2 PTS for 2 points) light up in measurement mode.
6. Repeat above steps for other calibration points as required.

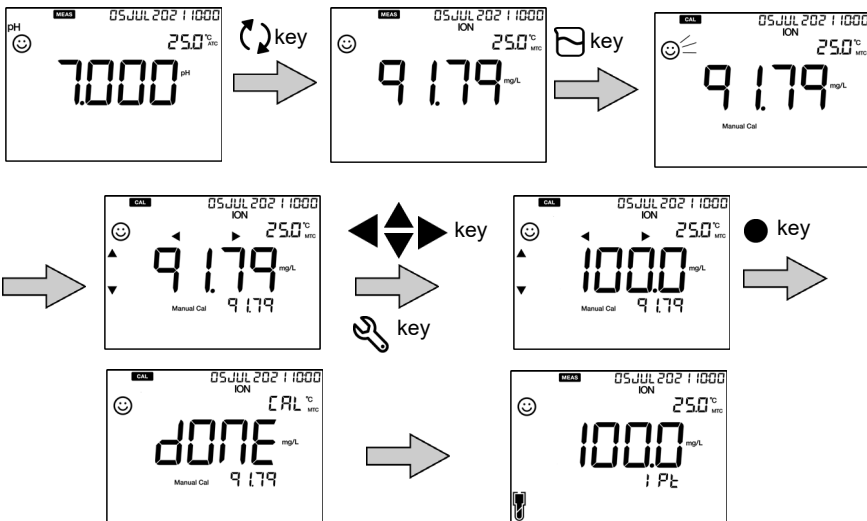

Note

To view and/or print calibration data, press the  key when you are in the **CAL** mode. The display scrolls through the calibrated values, segment slope(s), and average slope.

• DO Calibration

Calibration is necessary for accurate dissolved oxygen (DO) measurement. Two calibration modes are available in LAQUA-DO2000 and LAQUA-PD2000 benchtop meters for calibration.

- DO saturation mode (%)
- DO concentration mode (mg/L)

To perform various DO calibrations, follow the procedures detailed below:

Note

Set the barometric pressure (default 101.3 kPa) before calibration for accurate measurement.

• Calibration in DO Saturation Mode (%)

Prerequisites

- Clean the membrane at the tip of the DO electrode with DI (deionized) water and wipe it with tissue paper.
- Switch on the meter and plug in the DO electrode.
- Press the  key to keep the meter in DO saturation mode (%) mode.



Note

- Calibration performed in clean air is referred as air calibration.
 - Perform the air calibration in clean air at a location not subjected to dramatic temperature change, rain or direct wind.
 - Do not hold the tip of DO electrode with hand during calibration, as the electrode may be affected by temperature causing instability in calibration value.
-

Tip

- To abort an ongoing calibration process at any point of time, press the  key.
 - It is recommended to clear the previous calibration data before performing calibration. For erasing the calibration data, refer to “P1.4 Calibration Clear Setup” on page 45.
-

Air Calibration

1. Hold the DO electrode still in clean air and press the  key.
2. Wait for  to stabilize. When it stabilizes, there will be a sound indicating that reading is stable.
3. Press the **ENT**  key to confirm and save calibration data.
4. Meter displays **CAL DONE** indicating end of the air calibration procedure. Electrode icon and 100% icon light up in measurement mode.

Note



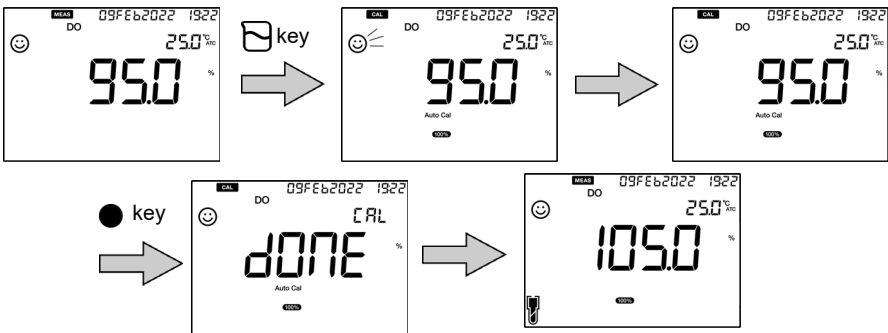

The electrode responds slightly differently to atmospheric air as compared to water. As such, 100% calibration in air will be shown as approximately 105%. Don't be alarmed by this. The reading in water will be accurate.



Note

To view and/or print calibration data, press the  key when you are in the **CAL** mode. The display scrolls through the calibrated values, span coefficient, and zero coefficient (if zero calibration is also performed).

Zero Calibration

1. After placing the DO electrode in the zero DO solution, press the  key.
2. Press the  key a second time. The meter displays zero calibration mode.
3. Wait for  to stabilize. When it stabilizes, there will be a sound indicating that reading is stable.
4. Press the **ENT**  key to confirm and save calibration data.

5. Meter displays **CAL DONE** indicating end of the zero calibration procedure. The 0% icon lights up in measurement mode.

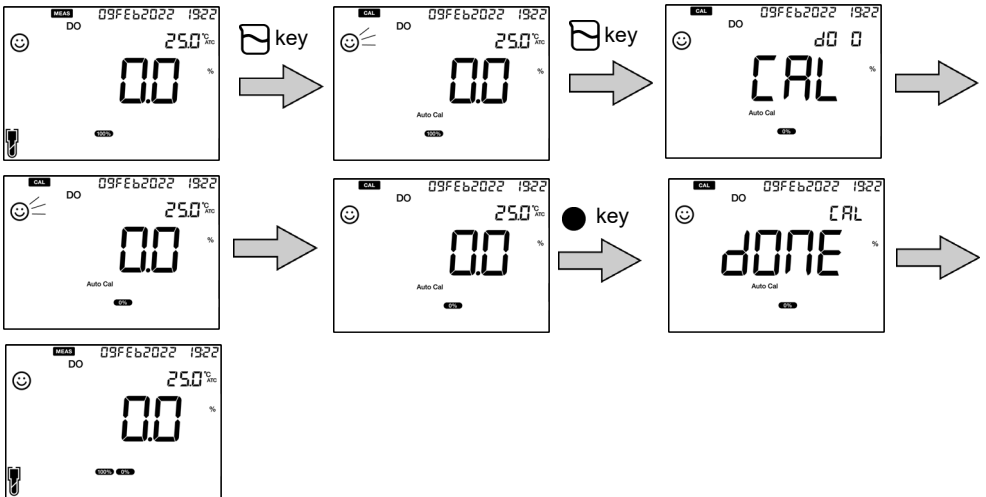

Note

- Calibration performed with zero DO solution is referred as zero calibration.
- Prepare zero DO solution by adding 2 g sodium sulfite (Na_2SO_3) to 1000 mL deionized water and stirring the mixture to completely dissolve the Na_2SO_3 .

• Calibration in DO Concentration Mode (mg/L)

Prerequisites

- Clean the membrane at the tip of the DO electrode with DI (deionized) water and wipe it with tissue paper.
- Prepare air-saturated water or water with known DO concentration and zero DO solution.
- Switch on the meter and plug in the DO electrode.
- Dip the DO electrode at least 6 cm in the water or solution.
- Press the  key to keep the meter in DO concentration mode (mg/L) mode.



Note

- Calibrate in the DO concentration mode in the order from high concentration solution to a low concentration solution. For the first calibration point, you may perform calibration in air-saturated water or in water with known DO concentration. For the second calibration point, you may perform calibration in zero DO solution.
- User can adjust the measured dissolved oxygen reading by manual calibration and the adjusted value is applied as an offset to the actual measurement.
- Prepare air-saturated water by aerating a sample of fresh water for about 2 hours.
- Stir the water or solution at 1000 to 1500 rpm using a magnetic stirrer.

Tip





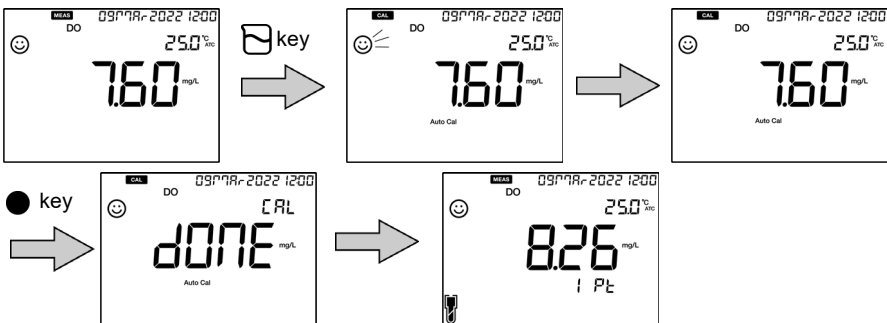

To abort an ongoing calibration process at any point of time, press the  key.

Calibration in Air-Saturated Water

1. After placing the DO electrode in air-saturated water, press the  key.
2. Wait for  to stabilize. When it stabilizes, there will be a sound indicating that reading is stable.
3. Press the **ENT**  key to confirm and save calibration data.
4. Meter displays **CAL done** indicating end of the calibration procedure. Electrode icon and 1 Pt light up in measurement mode.



Calibration in Water with Known DO Concentration

1. After placing the DO electrode in water with known DO concentration, press the  key.
2. Wait for  to stabilize. When it stabilizes, there will be a sound indicating that reading is stable.
3. Press   and   keys to adjust the DO reading.
4. Press the  key to confirm and save calibration data.

5. Meter displays **CAL done** indicating end of the calibration procedure. Electrode icon and 1 Pt light up in measurement mode.

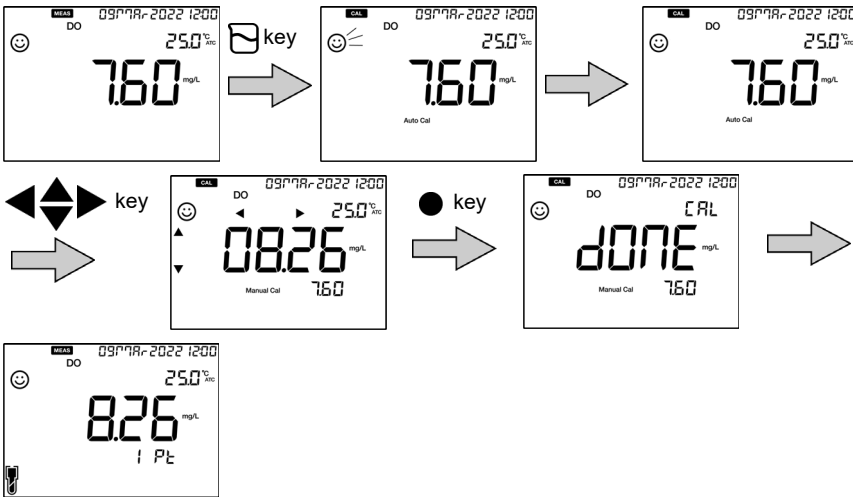

Calibration in Water with Zero DO Concentration

1. After placing the DO electrode in zero DO solution, press the key.
2. Press the key a second time. The meter displays zero calibration mode.
3. Wait for to stabilize. When it stabilizes, there will be a sound indicating that reading is stable.
4. Press the key to confirm and save calibration data.
5. Meter displays **CAL done** indicating end of the calibration procedure. 2 Pt lights up in measurement mode.

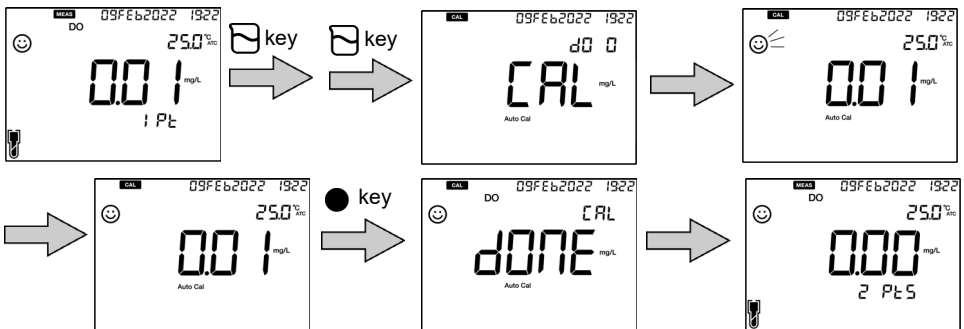

● Temperature Calibration

Temperature calibration is required to accurately match electrode to the meter. Check the temperature reading and if it is acceptable, no temperature calibration is required. If you need to calibrate, please follow the procedure detailed below:

Prerequisites

- Clean the electrode with DI (deionized) water and wipe it with tissue paper.
- Switch on the meter and plug in the electrode and temperature sensor.
- Dip the electrode in a solution with known temperature until its temperature sensor is immersed.
- Wait for 5 minutes to ensure temperature stability.





Note

- Meter displays **MTC** if the temperature sensor is not plugged in and displays **ATC** if the temperature sensor is plugged in.
 - Temperature calibration must be performed using a solution with known temperature or against a calibrated thermometer.
-

Tip

To abort an ongoing calibration process at any point of time, press the  key.

Calibration

1. After placing the electrode in a solution with known temperature, press the  key.
2. Press the  key to switch to temperature calibration mode. Meter displays measured temperature value.
3. Use the  and  keys to adjust the temperature to the required value.
4. Press the **ENT**  key to confirm and save calibration data.
5. Meter displays **CAL DONE** indicating end of the temperature calibration procedure.

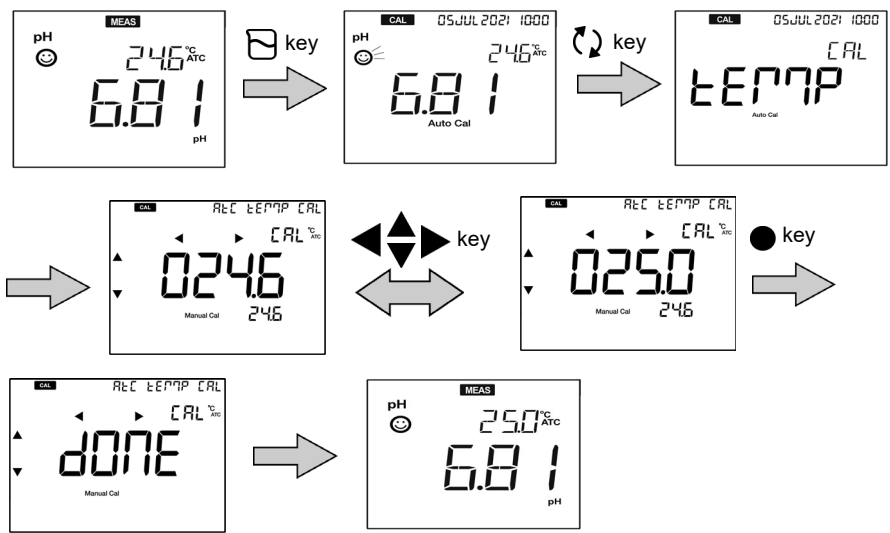

■ BOD Measurement

The 5-day biochemical oxygen demand (BOD) or BOD₅ test procedure consists of filling an airtight bottle of specified size with diluted and seeded sample to overflowing and incubating it for 5 days at 20°C. Dissolved oxygen (DO) is measured initially and after incubation, and the BOD is computed from the difference between initial and final DO.

The DO2000 and PD2000 bench meters can measure DO readings as well as compute and record the BOD of a sample corrected for seed and dilution effects when DO electrode is connected. Follow the procedure below to use the BOD method of DO2000 or PD2000 meter.

Prerequisites

- Prepare the sample to measure. Dilute and add seeding, if necessary.
- Clean the DO electrode with DI water and wipe it with tissue paper.
- Connect the DO electrode to the meter and perform DO calibration prior to BOD measurement.
- Switch **BOD** to **ON** in the BOD setup. If sample is seeded, switch **SEED** to **ON** to apply seed correction. Enter the seed and sample information.
- **AS** (Auto Stable) is the default reading stability mode in the general setup. Select either **AS** (Auto Stable) or **RT** (Real Time) reading stability mode. BOD method doesn't work in **AH** (Auto Hold) mode.
- Keep the meter in DO (mg/L) measurement mode.
- Dislodge any bubbles formed on the surface of the DO tip membrane after inserting the DO electrode into the BOD bottle filled with sample.

Tip

- When the BOD method is in use, the meter automatically detects and records the stable initial and final DO readings of sample, and subsequently computes the BOD and generates the report.
 - Once the initial DO of sample is recorded, the preset 5-day timer (corresponding to the 5-day incubation period) in the meter will start. Example: If initial DO is recorded at 9:00 am on April 9, the timer will expire at 9:00 am (same time) on April 14 (+5 days).
 - During the incubation period, the meter can be turned off or used to measure other parameters.
 - At the end of incubation, make sure that the meter is turned on and the DO electrode is connected and immersed in sample to measure and record the final DO before the timer stops.
 - To restart or abort an ongoing BOD measurement or clear existing BOD data, either switch **BOD** to **OFF** then **ON** again in the BOD setup or reset the meter.
-

Measurement

1. Insert the DO electrode into the BOD bottle filled with sample and start the stirrer. Allow the temperature of the DO electrode to equilibrate with the sample for few minutes.
2. If the meter is set to **AS** (Auto Stable) reading stability mode, wait for the ☺ to stabilize. When it stabilizes, there will be a sound indicating that reading is stable.
3. Press  key to start the BOD measurement. **START BOD** will appear on the meter screen briefly. The meter will record the stable reading as initial DO and mg/L unit will start blinking indicating that the BOD measurement and the timer have started.
4. Either keep the DO electrode immersed in sample or remove it during the 5-day incubation period. If the DO electrode is removed after the initial DO is measured, cover the BOD bottle with stopper and re-insert the DO electrode before the timer expires at the end of incubation.
5. Wait for the meter to automatically record the final DO of the sample at the end of incubation. The mg/L unit will stop blinking indicating that the BOD measurement has been completed and the timer has expired.

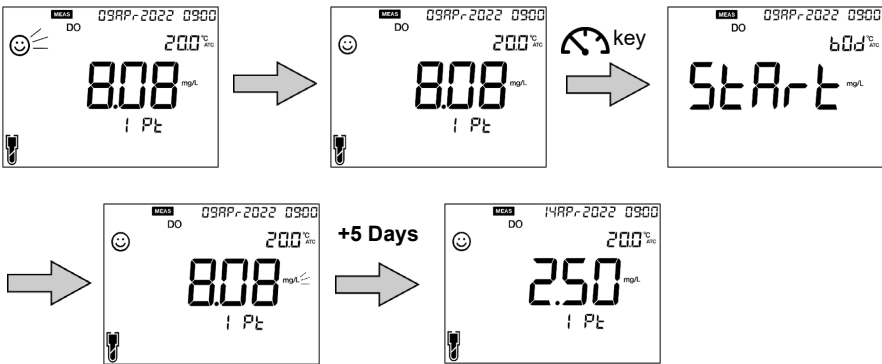

Note

To view and/or print BOD data, press  key when meter is in DO (mg/L) measurement mode. The display scrolls through sample BOD, initial DO reading, final DO (End DO) reading, sample volume, bottle volume, sample minimum DO, seed volume, and seed BOD.

■ Data

This section describes the procedures for storing data into the LAQUA-DO2000 and LAQUA-PD2000 benchtop meters and viewing them as well as transferring data from the meter to a PC.

● Data Capture and Storage

● Storing Data

Data measured by the instrument can be stored in the internal memory.





- To save the measured data, press the **ENT**  key.
- Meter displays the location number of the saved data for 2 seconds and then the previous screen automatically.



Note

- If the data storage limit reaches 2000, memory data full error occurs and **DATA FULL** is displayed.
- In such case, print or transfer necessary data to a PC and delete the data from the internal memory of the instrument.

● Viewing Stored Data

- To view stored data, press  key .
- Use   keys to scroll through all stored data.
- Press  key to return to measurement mode.

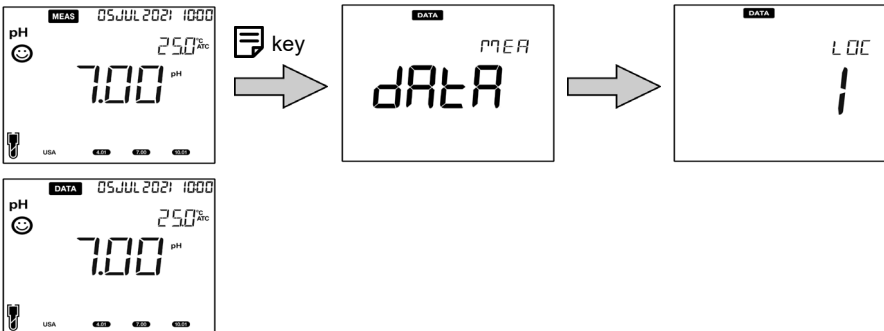

- **Data Transfer**





- **Transferring Data to PC**

Connect the instrument to a PC and Data Acquisition Software (DAS) using the phono to USB cable to transfer stored data.

1. Connect the phono jack of the cable to the back of the instrument and the USB connector to the communication port of the PC.
2. Install the DAS in the PC and follow the procedures in the DAS instruction sheet.

- **Printing Data**

Connect the instrument to a printer using the phono to 25-pin d-sub printer cable and follow the procedure below to print a data set.

1. In measurement mode, press  key.
2. Use   keys to view stored data.
3. Press  key to print the selected data.

- **Printer Format - Stored Data**

| HORIBA | |
|-------------|--------------|
| Model | PD2000 |
| S/No | A82C1234 |
| SW Rev | 1.00 |
| User Name | |
| Signature | |
| Logged Data | |
| Location | 1 |
| Date | 09MAR2022 |
| Time | 12:23:39 |
| Mode | DO |
| Stability | STABLE |
| DO | 100.0 %Sat |
| Temp. | 25.0 C (ATC) |
| Salinity | 0.0 ppt |
| Pressure | 101.3 kPa |
| Electrode | EXCELLENT |

Tip

To print entire stored data log, refer to “P2.2 Print Data Log Setup” on page 48.

■ Setup

This section describes the setups in LAQUA-DO2000 and LAQUA-PD2000 benchtop meters.

● P1 pH Setup

Using pH setup you can:

- Set pH buffer group
- Set pH resolution
- Set calibration alarm
- Erase calibration data

To set the pH function of LAQUA-PD2000, follow the procedure detailed below:

Prerequisites

- Switch on the meter.
- Ensure that the meter is in pH measurement mode.

Note







- Default pH buffer group in buffer setup is **USA**. You can change it to **NIST**, **NIST2**, **DIN**, or **CUST** (Custom) if required.
- Erasing previous calibration data is recommended for accurate calibration. Default calibration clear setup is **NO** but to erase the calibration data, change the setup to **YES**.

| pH Buffer Group | pH Buffer Values (25 °C) |
|-----------------|---|
| USA | 1.68, 4.01, 7.00, 10.01, 12.45 |
| NIST | 1.68, 4.01, 6.86, 9.18, 12.45 |
| NIST2 | 1.68, 4.01, 6.86, 10.01, 12.45 |
| DIN | 1.09, 3.06, 4.65, 6.79, 9.23, 12.75 |
| CUST | Use up to 6 pH buffers that are 1.0 pH apart for manual calibration |

Tip



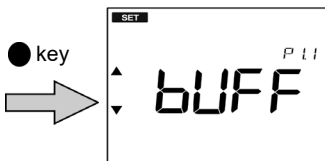
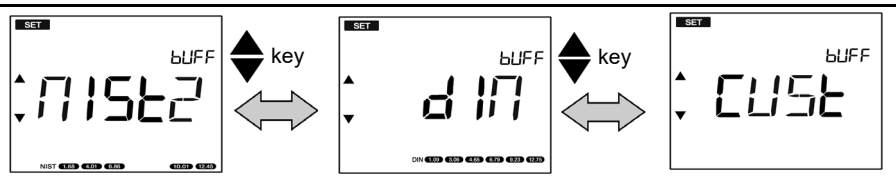
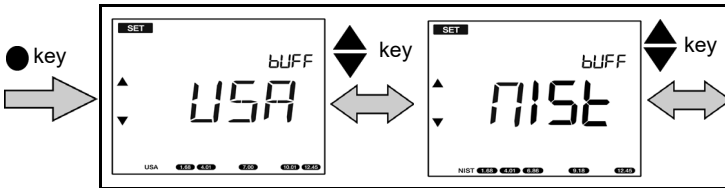
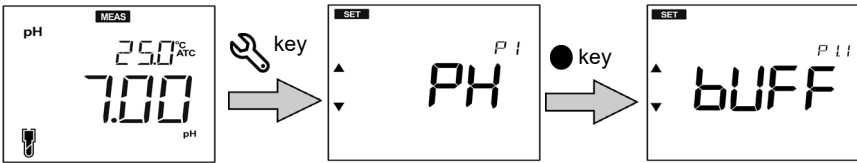

To return to the measurement mode, press the  key.

• P1.1 Buffer Setup

1. Press the  key, P1 PH screen appears.
2. Press the **ENT**  key, P1.1 BUFF screen appears.
3. Press the **ENT**  key, default **buff USA** appears.
4. Use the   keys to change the pH buffer group to **NIST**, **NIST2**, **DIN** or **CUST**.
5. Press the **ENT**  key, P1.1 BUFF screen appears. This indicates completion of pH buffer group setup.







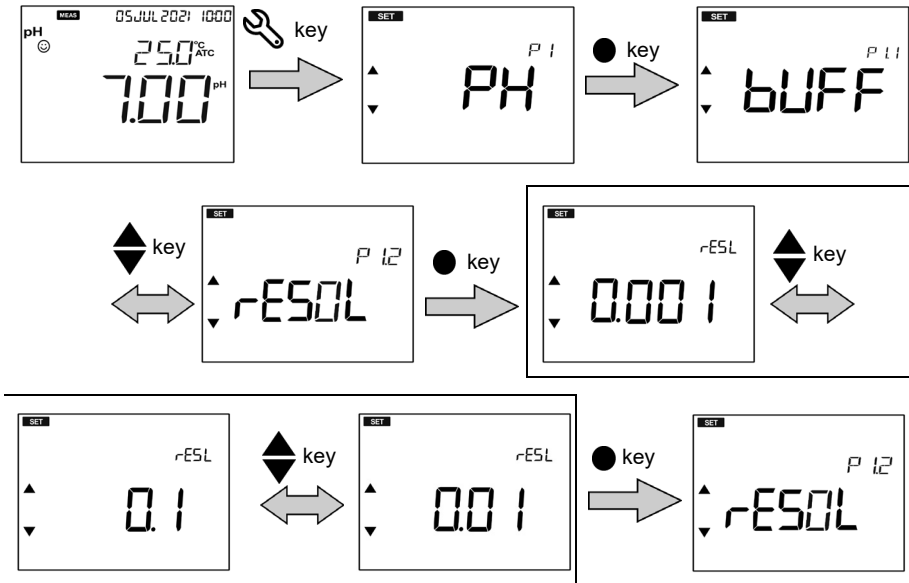





• P1.2 Resolution Setup

1. Press the  key, P1 PH screen appears.
2. Press the ENT  key, P1.1 BUFF screen appears.
3. Press the ▲ key, P1.2 RESOL screen appears.
4. Press the ENT  key, default resolution 0.001 screen appears.
5. Use the ▲ ▼ keys to change the resolution to 0.01 or 0.1.
6. Press the ENT  key, P1.2 RESOL screen appears. This indicates completion of resolution setup.







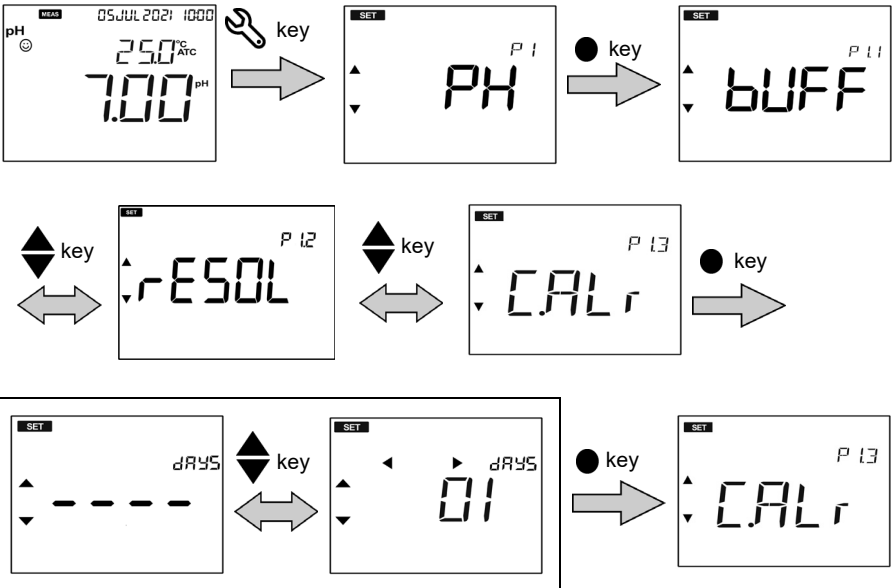



● **P1.3 Calibration Alarm Setup**

1. Press the  key, **P1 PH** screen appears.
2. Press the **ENT**  key, **P1.1 BUFF** screen appears.
3. Press the  key, **P1.2 RESOL** screen appears.
4. Press the  key, **P1.3 C.ALR** screen appears.
5. Press the **ENT**  key, default ---- **DAYS** screen appears.
6. Use the   and   keys to set number of days from 1 to 90.
7. Press the **ENT**  key, **P1.3 C.ALR** screen appears. This indicates completion of calibration alarm setup.



• P1.4 Calibration Clear Setup

1. Press the  key, **P1 PH** screen appears.
2. Press the **ENT**  key, **P1.1 BUFF** screen appears.
3. Press the  key, **P1.2 RESOL** screen appears.
4. Press the  key, **P1.3 C.ALR** screen appears.
5. Press the  key, **P1.4 C.CLR** screen appears.
6. Press the **ENT**  key, default **CCLR NO** screen appears.
7. Use the   keys to change to **YES**. This erases the calibration data.
8. Press the **ENT**  key, **CCLR DONE** screen appears briefly.
9. **P1.4 C.CLR** screen appears. This indicates completion of calibration clear setup.

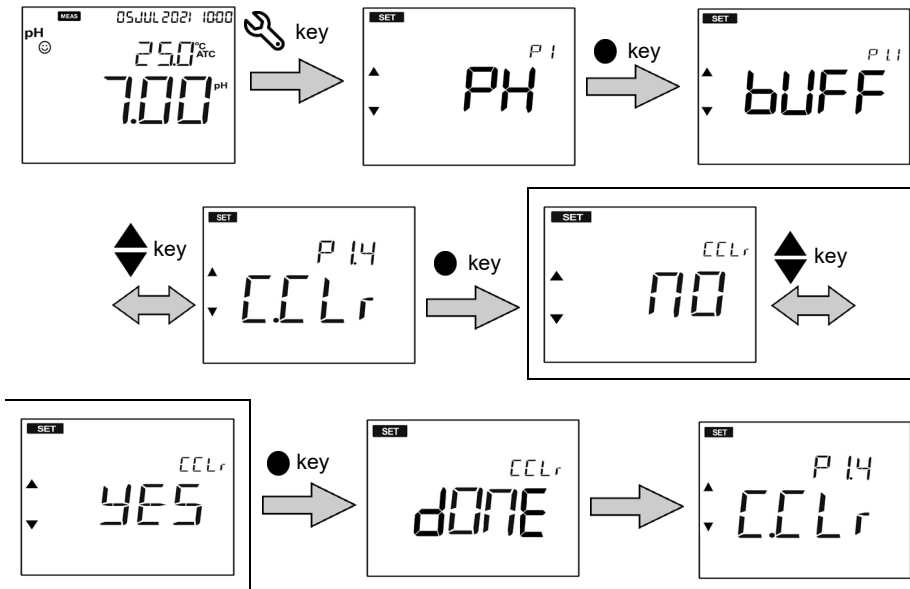

● P1 Ion Setup

Using ion setup you can:

- Select ion concentration unit
- Select ion electrode type or set the valence of the ion to be measured
- Erase calibration data

To set the ion function of LAQUA-PD2000, follow the procedure detailed below:





Prerequisites

- Switch on the meter.
- Ensure that the meter is in ion measurement mode.

Note







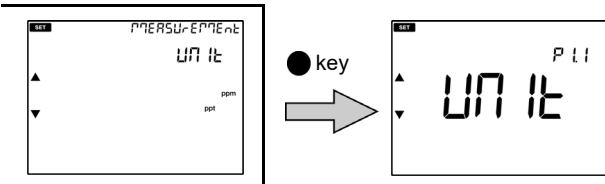
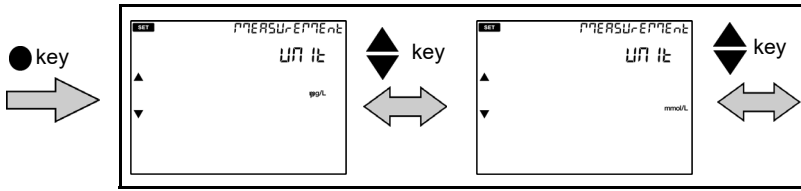



- Default ion concentration unit is $\mu\text{g/L} \leftrightarrow \text{mg/L} \leftrightarrow \text{g/L}$. You can change it to $\text{ppm} \leftrightarrow \text{ppt}$ or $\text{mmol/L} \leftrightarrow \text{mol/L}$, if required.
 - Default ion electrode type is **NH3** (Ammonia). You can change it to **CL** (Chloride), **FL** (Fluoride), **NO3** (Nitrate), **POT** (Potassium), **CA** (Calcium) or **CUST** (Custom). **CUST** is for setting the valence of the ion to be measured when the ion electrode type in use is not in the selection.
 - Erasing previous calibration data is recommended for accurate calibration. Default calibration clear setup is **NO** but to erase the calibration data, change the setup to **YES**.
-

● **P1.1 Ion Concentration Unit Setup**

1. Press the  key, **P1 ION** screen appears.
2. Press the **ENT**  key, **P1.1 UNIT** screen appears.
3. Press the **ENT**  key, default **µg/L ↔ mg/L ↔ g/L** appears.
4. Use the **▲ ▼** keys to change the ion concentration unit to **ppm ↔ ppt** or **mmol/L ↔ mol/L**.
5. Press the **ENT**  key, **P1.1 UNIT** screen appears. This indicates completion of ion concentration unit setup.







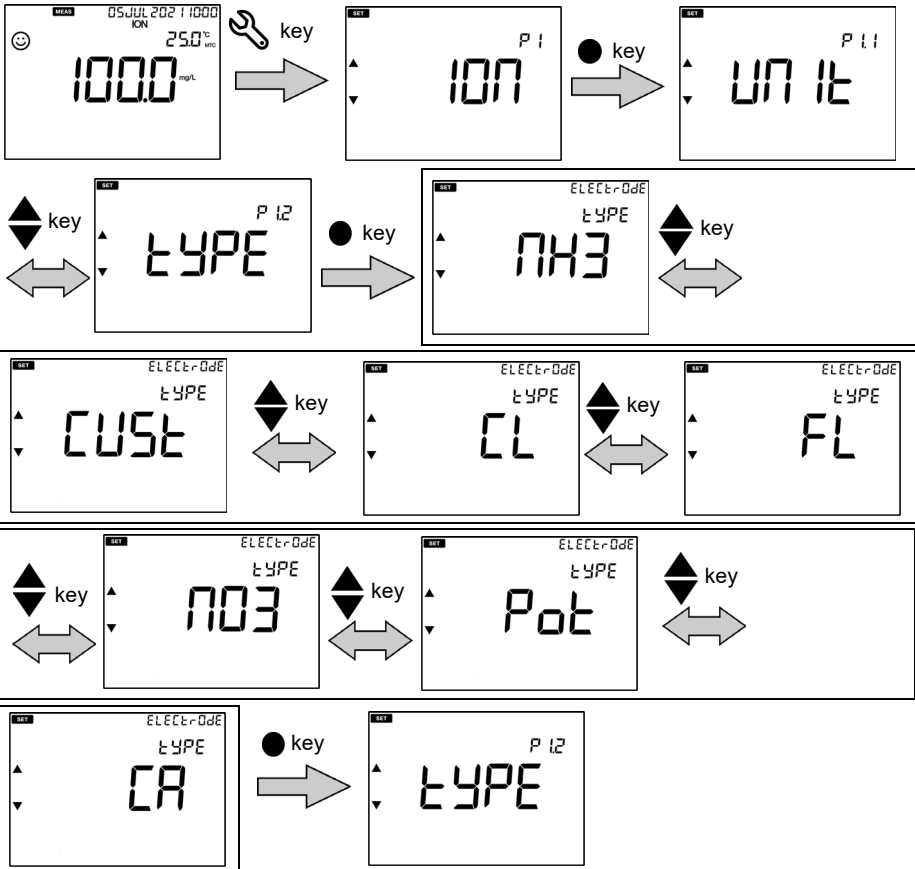

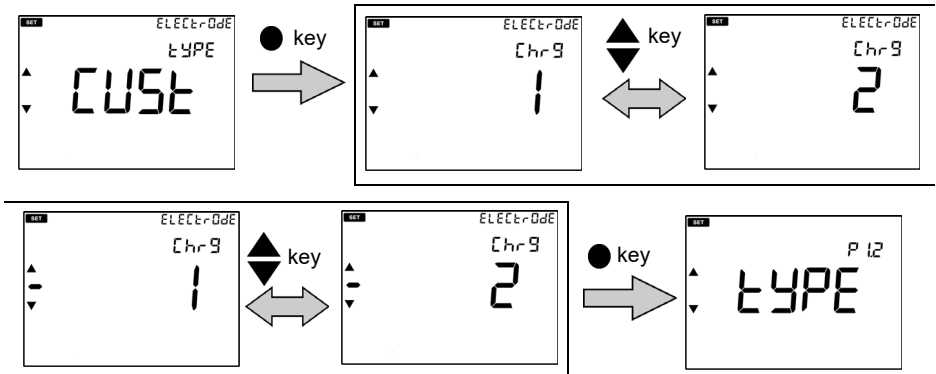

● **P1.2 Ion Electrode Type Setup**

1. Press the  key, **P1 ION** screen appears.
2. Press the **ENT**  key, **P1.1 UNIT** screen appears.
3. Press the **▲**  key, **P1.2 TYPE** screen appears.
4. Press the **ENT**  key, default **NH3** (Ammonia) ion electrode type appears.
5. Use the **▲**  **▼**  keys to change the electrode type to **CA** (Calcium), **POT** (Potassium), **NO3** (Nitrate), **FL** (Fluoride), **CL** (Chloride), or **CUST** (Custom). If **CUST** is selected, default **CHRG 1** screen appears after pressing  key. Use **▲**  **▼**  arrows to change to **-1**, **2**, or **-2** depending on the valence of the ion to be measured.
6. Press the **ENT**  key, **P1.2 TYPE** screen appears indicating completion of ion electrode type setup.





● **P1.3 Calibration Clear Setup**

1. Press the  key, **P1 ION** screen appears.
2. Press the **ENT**  key, **P1.1 UNIT** screen appears.
3. Press the  key, **P1.2 TYPE** screen appears.
4. Press the  key, **P1.3 C.CLR** screen appears.
5. Press the **ENT**  key, default **CCLR NO** screen appears.
6. Use the   keys to change to **YES**. This erases the ion calibration data.
7. Press the **ENT**  key, **CCLR DONE** screen appears briefly.
8. **P1.3 C.CLR** screen appears. This indicates completion of calibration clear setup.

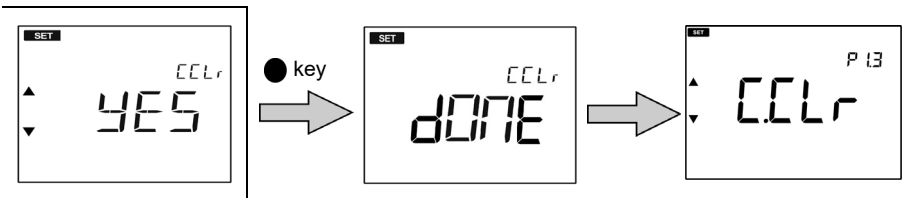
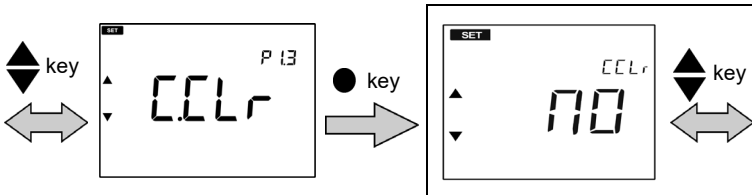
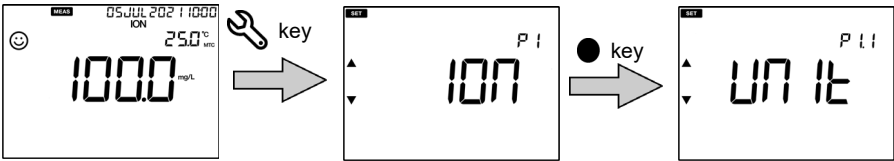

• P1 DO Setup

Using DO setup you can:

- Set salinity value
- Set barometric pressure
- Set BOD
- Erase calibration data

To set the DO function, follow the procedure detailed below:









Prerequisites

- Switch on the meter.
- Ensure that the meter is in DO measurement mode.

Note







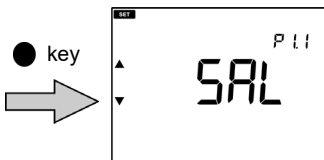
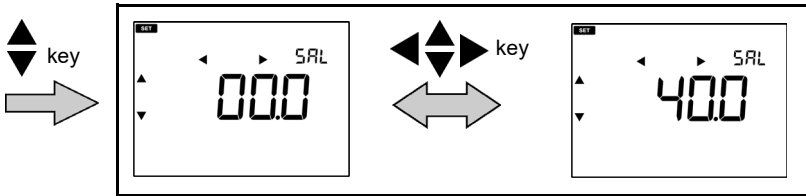

- Default salinity value is **00.0 ppt**. You can set a value in between **00.0 to 40.0 ppt**.
 - Default barometric pressure is **101.3 kPa**. You can set a value in between **10.0 to 200.0 kPa**.
 - BOD setup allows you to enter seed and sample information for BOD measurement and calculation. Default BOD is **OFF**. To use the BOD method of the meter for BOD measurement, set BOD to **ON**. BOD can be calculated with or without seed correction. Default seed correction is **OFF**. Change to **ON** to apply seed correction.
 - Erasing previous calibration data is recommended for accurate calibration. Default calibration clear setup is **NO** but to erase the calibration data, change the setup to **YES**.
-

● **P1.1 Salinity Value Setup**

1. Press the  key, **P1 DO** screen appears.
2. Press the **ENT**  key, **P1.1 SAL** screen appears.
3. Press the **ENT**  key, default **SAL 00.0 ppt** appears.
4. Use the   and   keys to adjust the salinity value in between **00.0** to **40.0 ppt**.
5. Press the **ENT**  key, **P1.1 SAL** screen appears. This indicates completion of salinity value setup.







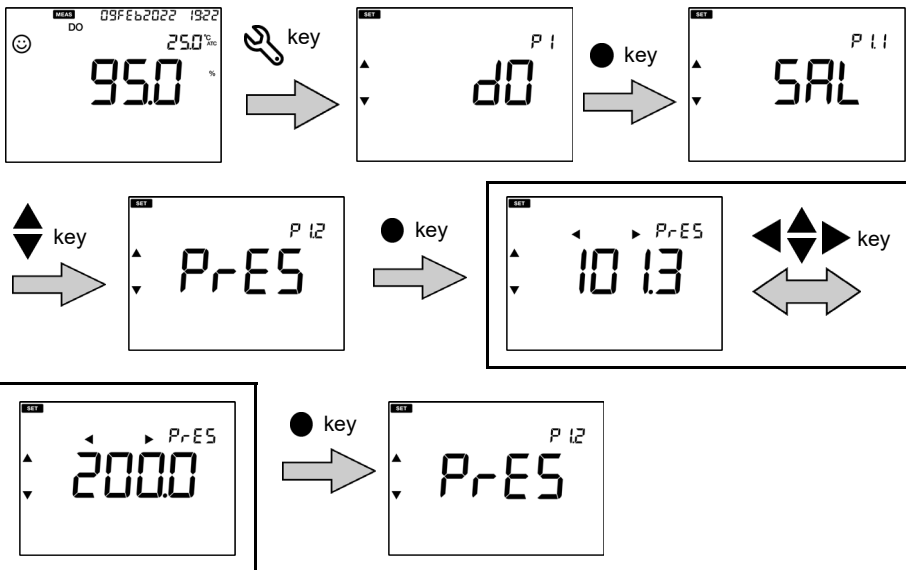



















• P1.2 Barometric Pressure Setup

1. Press the  key, **P1 DO** screen appears.
2. Press the **ENT**  key, **P1.1 SAL** screen appears.
3. Press the  key, **P1.2 PRES** screen appears.
4. Press the **ENT**  key, default **PRES 101.3 kPa** appears.
5. Use the   and   keys to adjust the barometric pressure in between **10.0** to **200.0 kPa**.
6. Press the **ENT**  key, **P1.2 PRES** screen appears. This indicates completion of barometric pressure setup.



• **P1.3 BOD Setup**





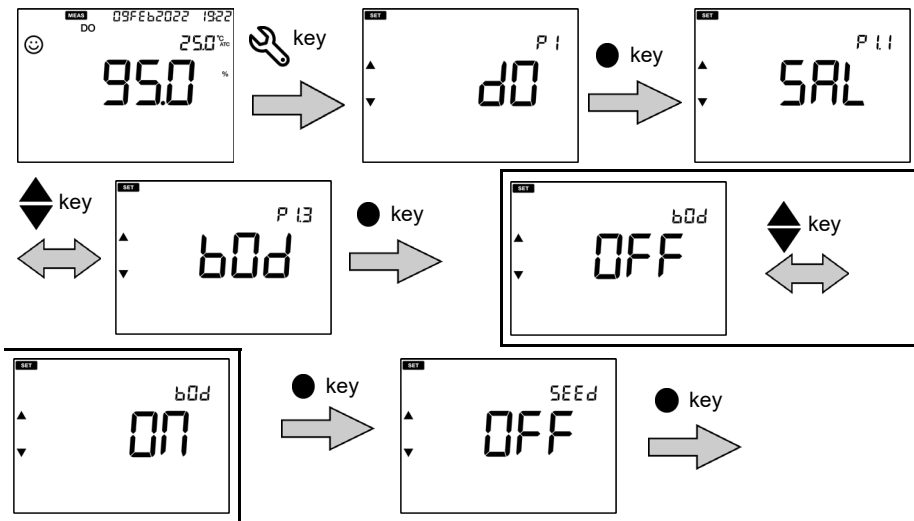

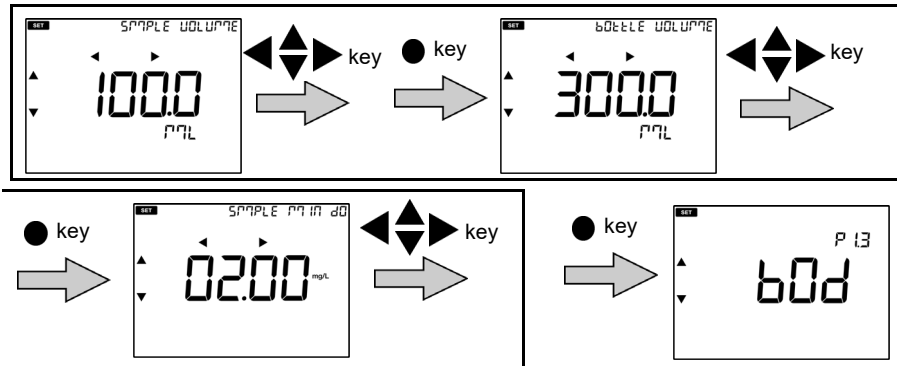



























Without Seed Correction

1. Press the  key, **P1 DO** screen appears.
2. Press the **ENT**  key, **P1.1 SAL** screen appears.
3. Press the  key, **P1.2 PRES** screen appears.
4. Press the  key, **P1.3 BOD** screen appears.
5. Press the **ENT**  key, default **BOD OFF** screen appears.
6. Use the   keys to change to **ON**.
7. Press the **ENT**  key, default **SEED OFF** screen appears.
8. Press the **ENT**  key, default **SAMPLE VOLUME 100.0 ml** screen appears. Use the   and   keys to adjust the sample volume.
9. Press the **ENT**  key, default **BOTTLE VOLUME 300.0 ml** screen appears. Use the   and   keys to adjust the bottle volume.
10. Press the **ENT**  key, default **SAMPLE MINIMUM DO 2.00 mg/L** screen appears. Use the   and   keys to adjust the sample minimum DO.
11. Press the **ENT**  key, **P1.3 BOD** screen appears. This indicates completion of BOD setup.











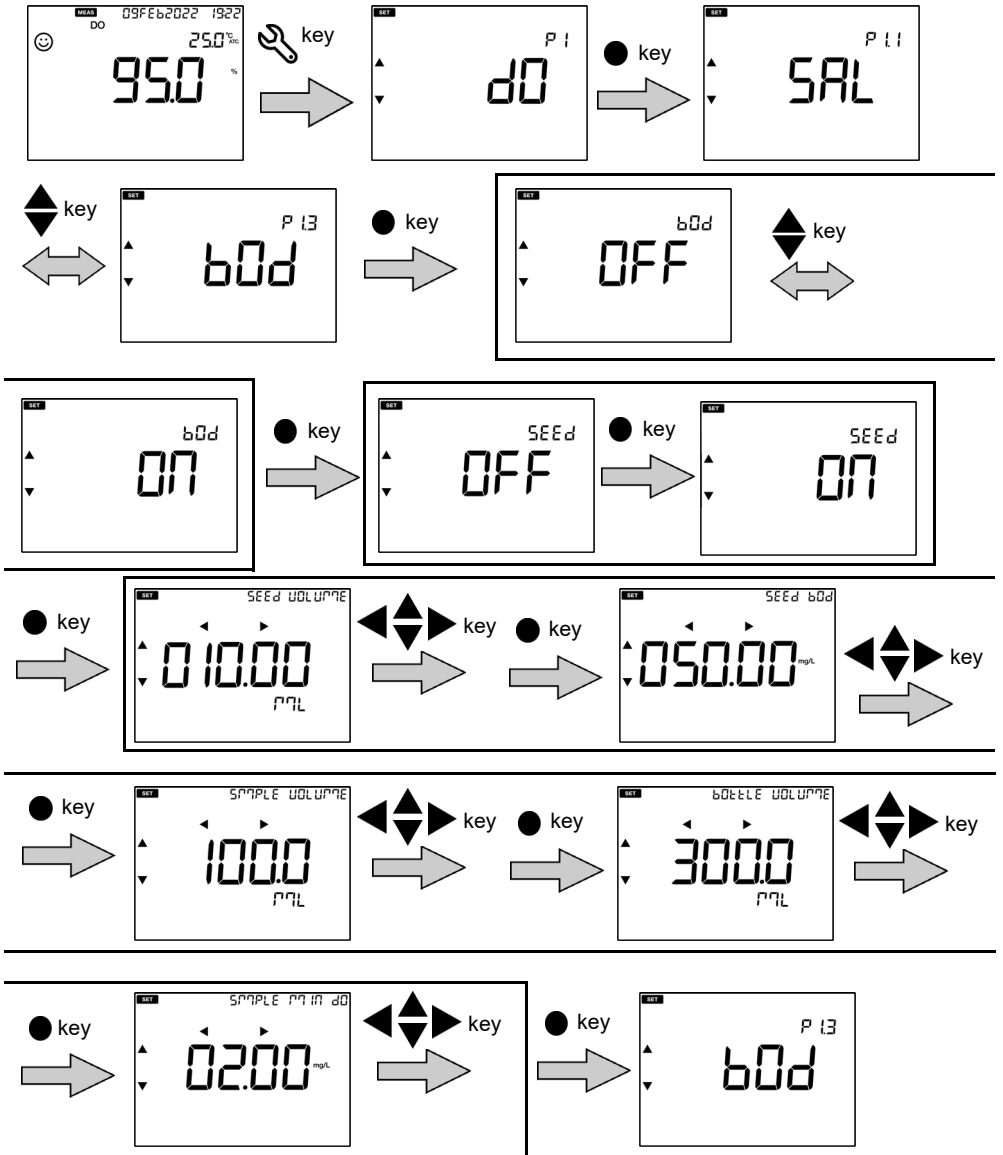



With Seed Correction

1. Press the  key, **P1 DO** screen appears.
2. Press the **ENT**  key, **P1.1 SAL** screen appears.
3. Press the  key, **P1.2 PRES** screen appears.
4. Press the  key, **P1.3 BOD** screen appears.
5. Press the **ENT**  key, default **BOD OFF** screen appears.
6. Use the   keys to change to **ON**.
7. Press the **ENT**  key, default **SEED OFF** screen appears.
8. Use the   keys to change to **ON**.
9. Press the **ENT**  key, default **SEED VOLUME 10.00 ml** screen appears. Use the   and   keys to adjust the seed volume in sample.
10. Press the **ENT**  key, default **SEED BOD 50.00 mg/L** screen appears. Use the   and   keys to adjust the seed BOD value.
11. Press the **ENT**  key, default **SAMPLE VOLUME 100.0 ml** screen appears. Use the   and   keys to adjust the sample volume.
12. Press the **ENT**  key, default **BOTTLE VOLUME 300.0 ml** screen appears. Use the   and   keys to adjust the bottle volume.
13. Press the **ENT**  key, default **SAMPLE MINIMUM DO 2.00 mg/L** screen appears. Use the   and   keys to adjust the sample minimum DO.

14. Press the **ENT** ● key, **P1.3 BOD** screen appears. This indicates completion of BOD setup.



• P1.4 Calibration Clear Setup

1. Press the  key, **P1 DO** screen appears.
2. Press the **ENT**  key, **P1.1 SAL** screen appears.
3. Press the  key, **P1.2 PRES** screen appears.
4. Press the  key, **P1.3 BOD** screen appears.
5. Press the  key, **P1.4 C.CLR** screen appears.
6. Press the **ENT**  key, default **CCLR NO** screen appears.
7. Use the   keys to change to **YES**. This erases the DO calibration data.
8. Press the **ENT**  key, **CCLR DONE** screen appears briefly.
9. **P1.4 C.CLR** screen appears. This indicates completion of calibration clear setup.

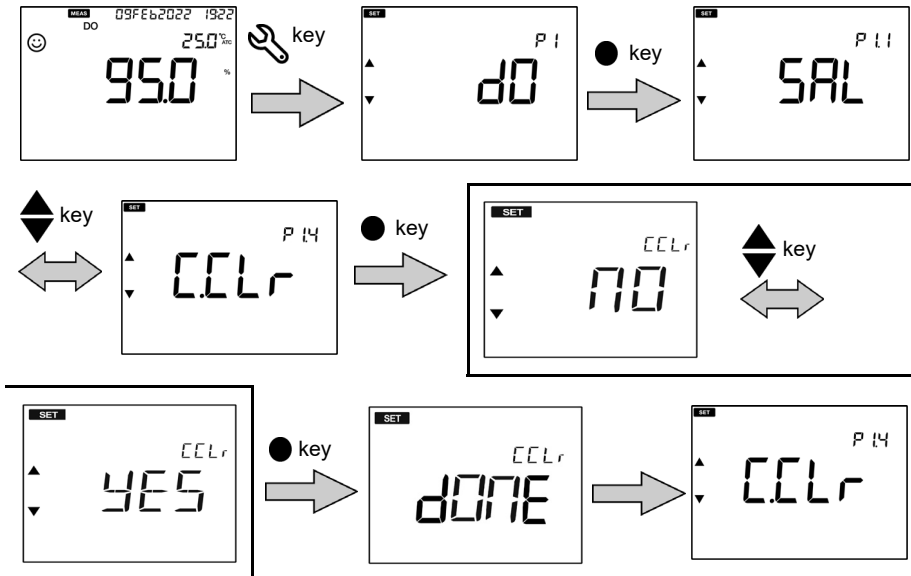

● P2 Data Setup

Using data setup, you can:

- Set data log interval
- Print data log
- Erase data log

To set the data function, follow the procedure detailed below:

Prerequisites

- Switch on the meter.
- Keep the meter either in pH or ion or DO mode.









Note

- Default data log interval is “----” which indicates no data log interval has been set. Data log interval can be set from 2 to 999 seconds.
-

Tip

To return to the measurement mode, press the  key.

• P2.1 Data Log Interval Setup



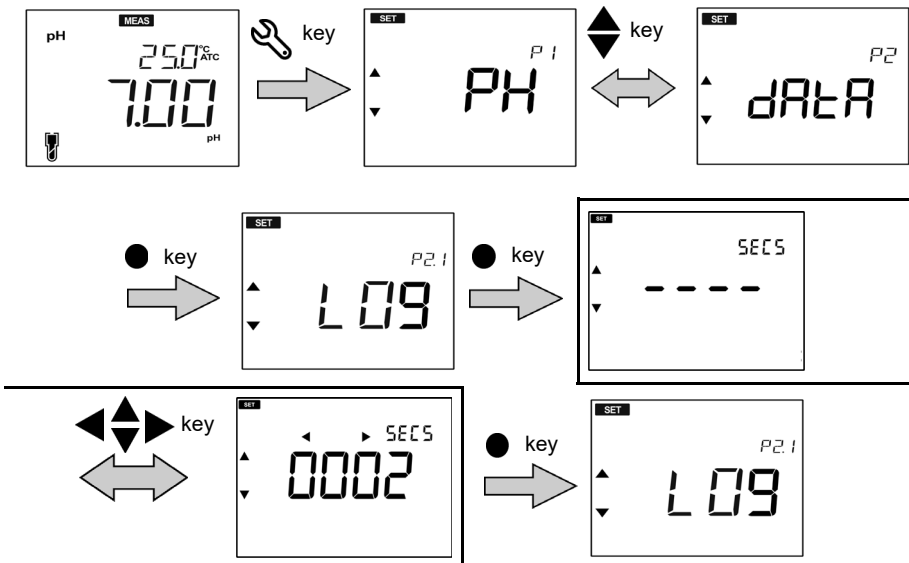





1. Press the  key, P1 PH / ION / DO screen appears.
2. Press the  key, P2 DATA screen appears.
3. Press the **ENT**  key, P2.1 LOG screen appears.
4. Press the **ENT**  key, default ---- log interval appears.
5. Use the   and   keys to set the data log interval from 2 to 999 seconds.
6. Press the **ENT**  key, P2.1 LOG screen appears. This indicates completion of data log interval setup.



Tip

To start and stop auto data logging in measurement mode, press  key.

● **P2.2 Print Data Log Setup**



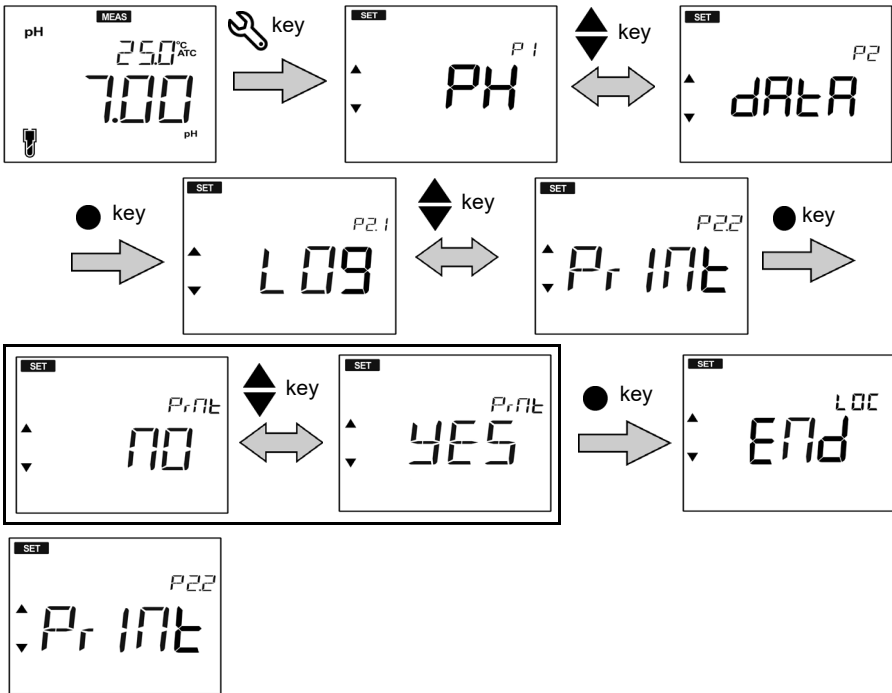





1. Press the  key, **P1 PH / ION / DO** screen appears.
2. Press the  key, **P2 DATA** screen appears.
3. Press the **ENT**  key, **P2.1 LOG** screen appears.
4. Press the  key, **P2.2 PRINT** screen appears.
5. Press the **ENT**  key, default **NO** appears.
6. Use the   keys to change to **YES**. This prints all stored data.
7. Press the **ENT**  key, **LOC END** screen appears briefly after the last data is printed.
8. **P2.2 PRINT** screen appears. This indicates the completion of the print data log setup.



Tip

To stop the printing process, press and hold the  key.

• P2.3 Data Log Clear Setup

1. Press the  key, P1 PH / ION / DO screen appears.
2. Press  key, P2 DATA screen appears.
3. Press the  key, P2.1 LOG screen appears.
4. Press the  key, P2.2 PRINT screen appears.
5. Press the  key, P2.3 D.CLR screen appears.
6. Press the  key, default NO appears
7. Use the   keys to change to YES. This erases all data.
8. Press the  key, D.CLR DONE screen appears briefly.
9. P2.3 D.CLR screen appears. This indicates the completion of data log clear setup.

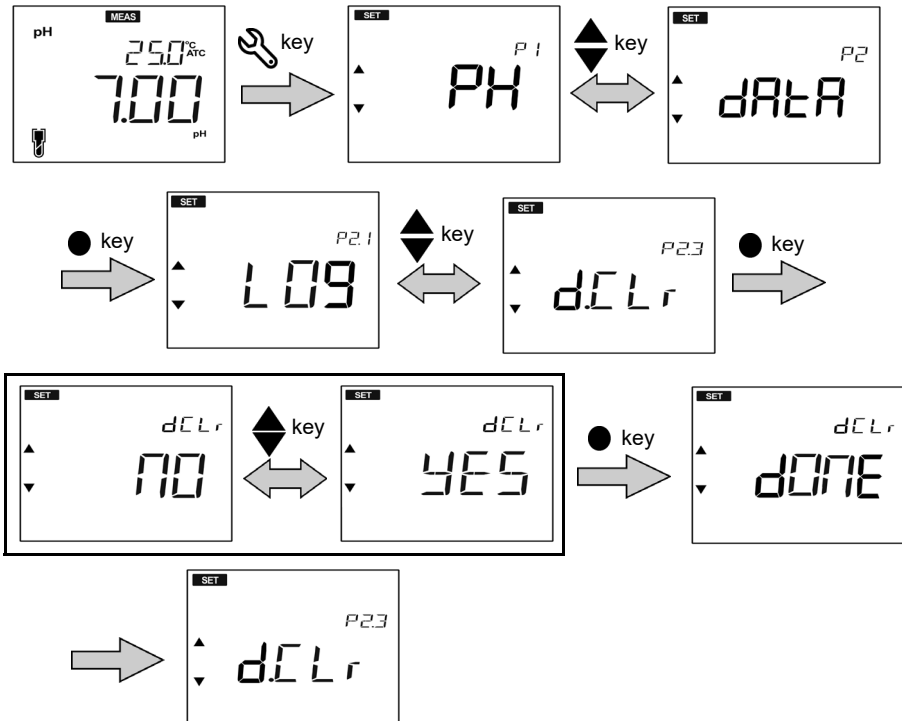

• P3 General Setup

Using general setup, you can:

- Set reading stability mode
- Set auto shut-off time
- Set temperature unit
- Set password for setup mode
- Reset the meter

To set the general function, follow the procedure detailed below:

Prerequisites

- Switch on the meter.
- Keep the meter in either pH or ion or DO mode.

Note

- In calibration mode, the Auto Stable (**AS**) mode is activated. Default reading stability mode setup in measurement mode is Auto Stable (**AS**). You can change it to Auto Hold (**AH**) or Real Time (**RT**).
 - Default auto shut-off time is 30 minutes. You can set the time from ---- to 30 minutes, where ---- indicates “no auto shut-off time” has been set and meter will be “on” continuously.
 - Default temperature unit is °C and you can change it to °F.
 - Default reset meter setup is **NO**. You can change it to **YES**.
-

Tip









- Stability judgment criteria remains same for both Auto Stable mode and Auto Hold mode.
 - To return to the measurement mode, press the  key.
-

• **P3.1 Reading Stability Mode Setup**

Auto Stable (AS) Mode – The meter shows live readings; 😊 blinks until reading is stable.







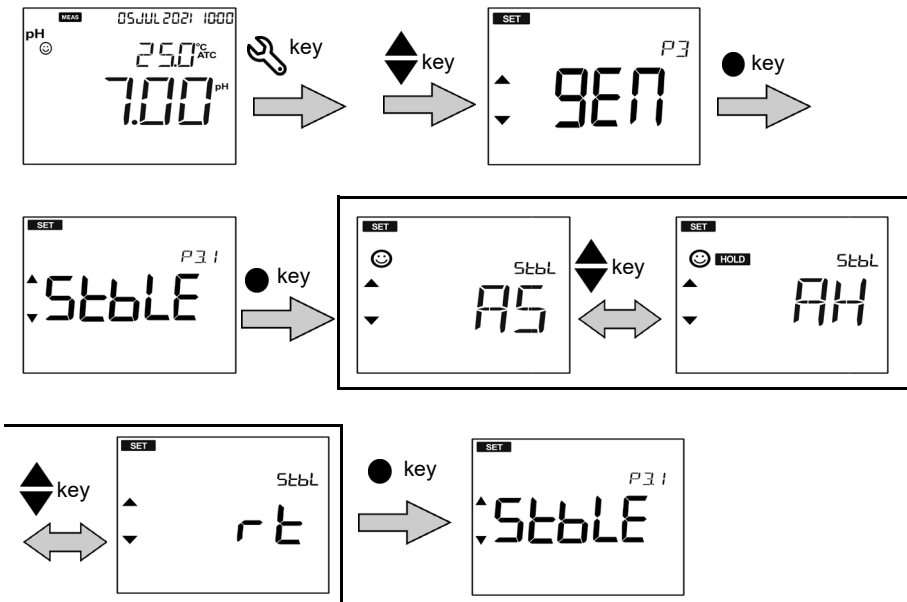



Auto Hold (AH) Mode – The meter locks the stable reading; 😊 blinks until reading is stable and then **HOLD** lights up.

Real Time (RT) Mode – The meter shows live readings; both 😊 and **HOLD** are inactive.

1. Press the  key, **P1 PH / ION / DO** screen appears.
2. Press  key, **P2 DATA** screen appears.
3. Press  key, **P3 GEN** screen appears.
4. Press the **ENT**  key, **P3.1 STBLE** screen appears.
5. Press the **ENT**  key, the default **AS** (Auto Stable) reading stability mode appears.
6. Use the   keys to change to **AH** (Auto Hold) or **RT** (Real Time).
7. Press the **ENT**  key, **P3.1 STBLE** screen appears. This indicates completion of the reading stability mode setup.







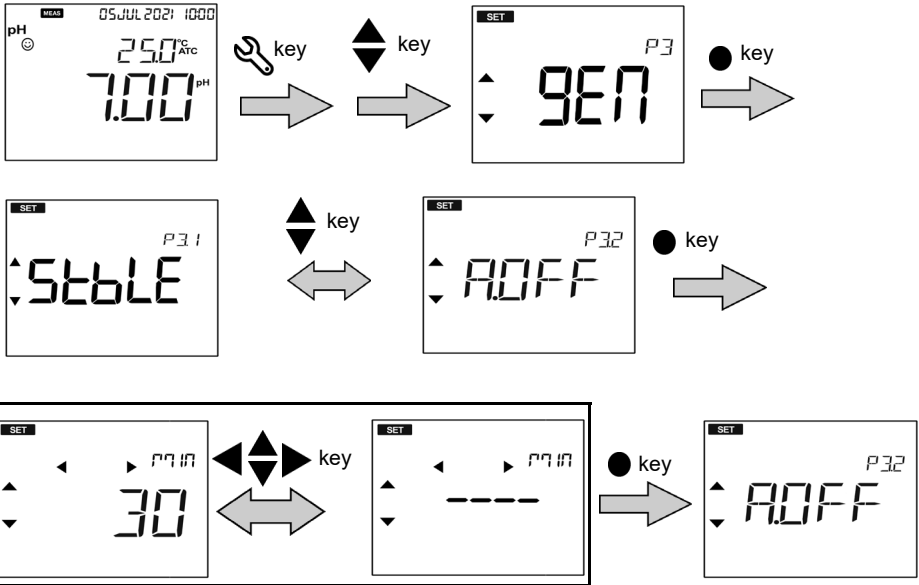





● **P3.2 Auto Shut-off Time Setup**

1. Press the  key, **P1 PH / ION / DO** screen appears.
2. Press the  key, **P2 DATA** screen appears.
3. Press the  key, **P3 GEN** screen appears.
4. Press the **ENT**  key, **P3.1 STBLE** screen appears.
5. Press the  key, **P3.2 A.OFF** screen appears.
6. Press the **ENT**  key, default auto shut-off time **30 minutes** appear.
7. Use the   and   keys to adjust the auto shut-off time from ---- to 30 minutes.
8. Press the **ENT**  key, **P3.2 A.OFF** screen appears. This indicates completion of the auto shut-off time setup.







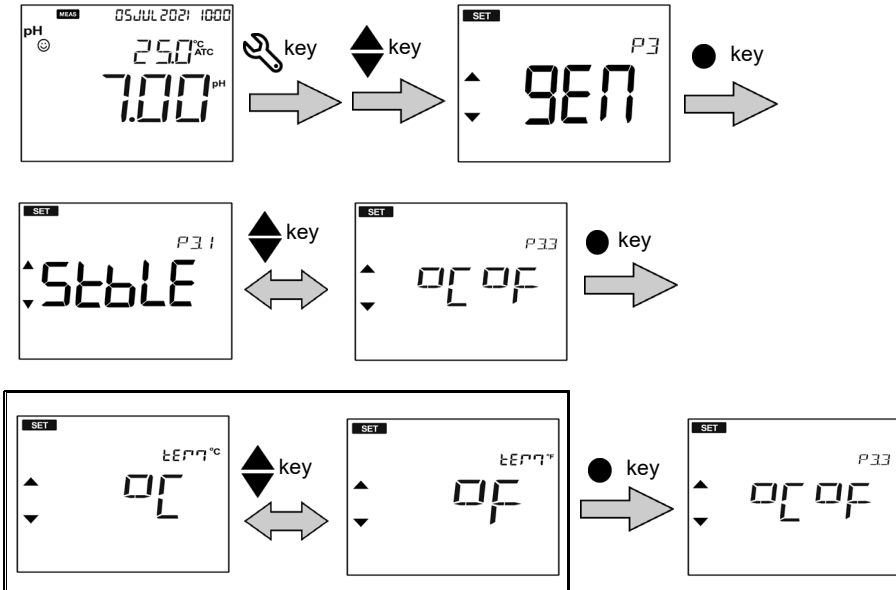









● **P3.3 Temperature Unit Setup**

1. Press the  key, **P1 PH / ION / DO** screen appears.
2. Press the  key, **P2 DATA** screen appears.
3. Press the  key, **P3 GEN** screen appears.
4. Press the  key, **P3.1 STBLE** screen appears.
5. Press the  key, **P3.2 A.OFF** screen appears.
6. Press the  key, **P3.3 °C°F** screen appears.
7. Press the **ENT**  key, default temperature unit °C appears.
8. Use the   keys to change to °F.
9. Press the **ENT**  key, **P3.3 °C°F** screen appears. This indicates completion of the temperature unit setup.







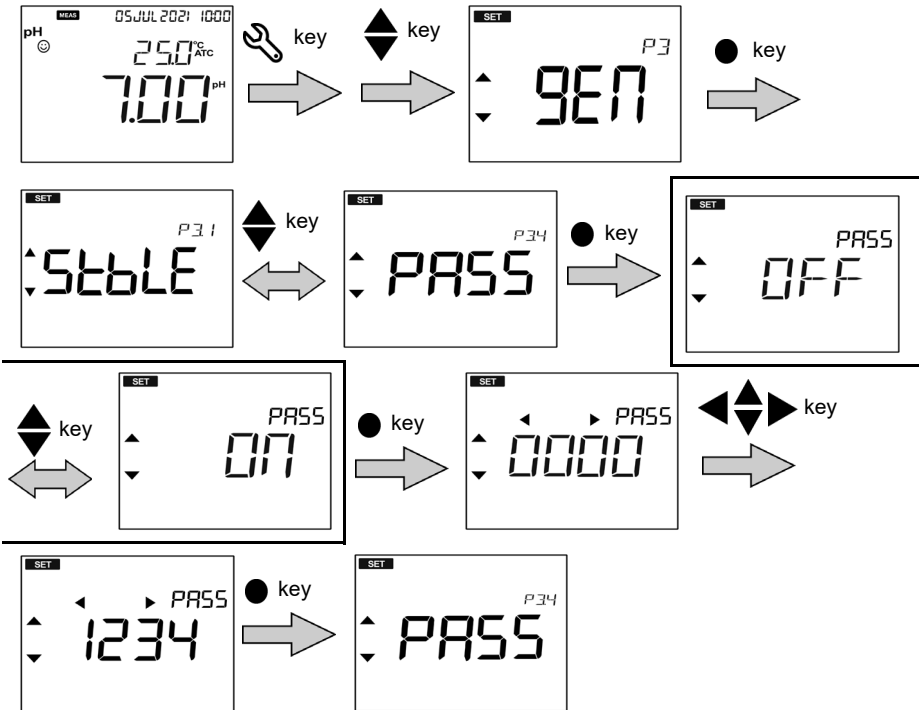







● **P3.4 Password Setup**

1. Press the  key, **P1 PH / ION / DO** screen appears.
2. Press the  key, **P2 DATA** screen appears.
3. Press the  key, **P3 GEN** screen appears.
4. Press the **ENT**  key, **P3.1 STBLE** screen appears.
5. Press the  key, **P3.2 A.OFF** screen appears.
6. Press the  key, **P3.3 °C°F** screen appears.
7. Press the  key, **P3.4 PASS** screen appears.
8. Press the **ENT**  key, default **PASS OFF** appears.
9. Press the  key, **PASS ON** screen appears. This restricts access to setup mode.
10. Press the  key. Use the   and   key to set password up to 4 digits.
11. Press the  key, **P3.4 PASS** screen appears. This indicates completion of the password setup.



● **P3.5 Reset Setup**

1. Press the  key, **P1 PH / ION / DO** screen appears.
2. Press the  key, **P2 DATA** screen appears.
3. Press the  key, **P3 GEN** screen appears.
4. Press the **ENT**  key, **P3.1 STBLE** screen appears.
5. Press the  key, **P3.2 A.OFF** screen appears.
6. Press the  key, **P3.3 °C°F** screen appears.
7. Press the  key, **P3.4 PASS** screen appears.
8. Press the  key, **P3.5 RESET** screen appears.
9. Press the **ENT**  key, default reset **NO** appears.
10. Use the   key to change to **YES**. This resets the meter to factory default values.
11. Press the  key, meter displays **RESET DONE** and then **RESET END** briefly, before it automatically switches off.

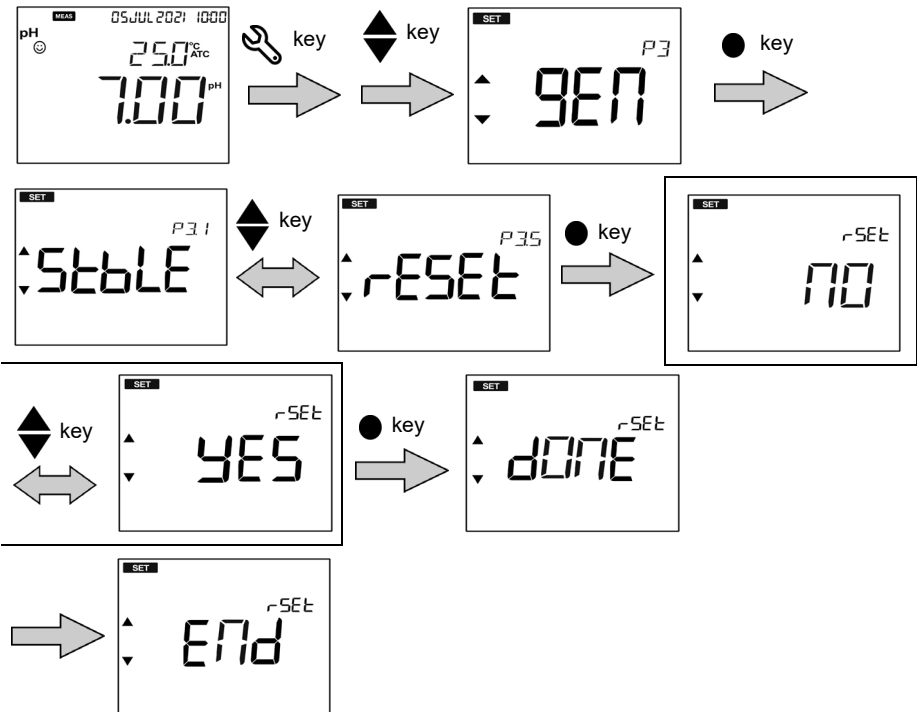

• P4 Clock Setup

Using real-time clock setup, you can set date and time. Follow the procedure detailed below:

Prerequisites

- Switch on the meter.
- Keep the meter in either pH or ion or DO mode.



















Note

- Setting the date and time is necessary before using the instrument for the first time.
 - Date and time are captured correctly when saving measurement data in the internal memory.
-

Tip







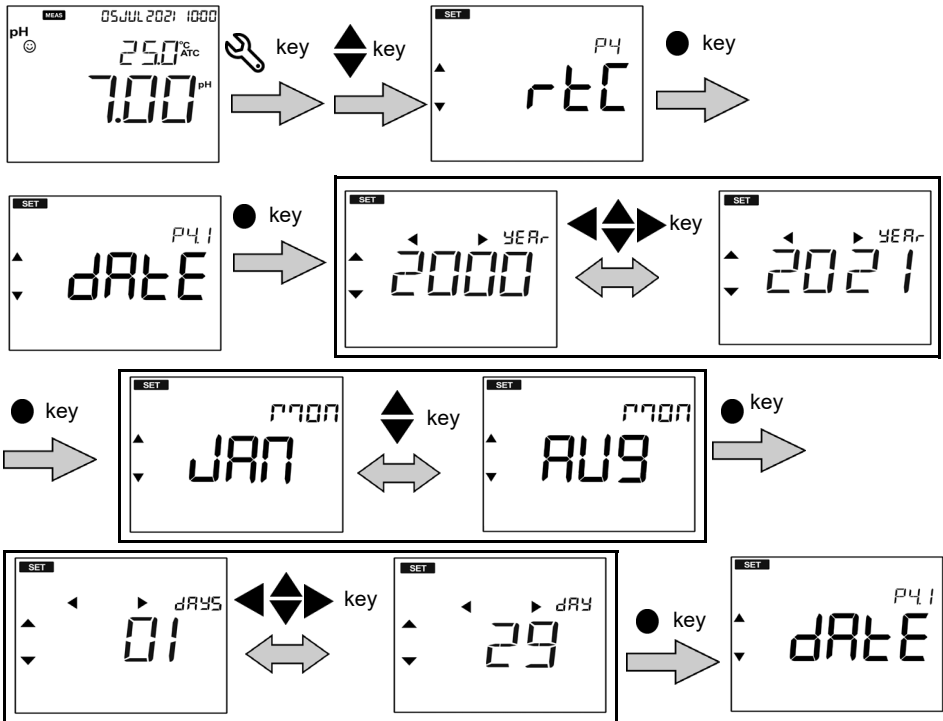









To return to the measurement mode, press the  key.

● **P4.1 Date Setup**

1. Press the  key, **P1 PH / ION / DO** screen appears.
2. Press the  key, **P2 DATA** screen appears.
3. Press the  key, **P3 GEN** screen appears.
4. Press the  key, **P4 RTC** screen appears.
5. Press the **ENT**  key, **P4.1 DATE** screen appears.
6. Press the **ENT**  key, default set year appears.
7. Use the   and   keys to change the year.
8. Press the **ENT**  key, default set month appears.
9. Use the   keys to change the month.
10. Press the **ENT**  key, default set day appears.
11. Use the   and   keys to change the day.
12. Press the **ENT**  key, **P4.1 DATE** screen appears. This indicates completion of the date setup.



● **P4.2 Time Setup**

1. Press the  key, **P1 PH / ION / DO** screen appears.
2. Press the  key, **P2 DATA** screen appears.
3. Press the  key, **P3 GEN** screen appears.
4. Press the  key, **P4 RTC** screen appears.
5. Press the **ENT**  key, **P4.1 DATE** screen appears.
6. Press the  key, **P4.2 TIME** screen appears.
7. Press the **ENT**  key, default set hour appears.
8. Use the   and   keys to change the hour.
9. Press **ENT**  key, default set minute appears.
10. Use the   and   keys to change the minute.
11. Press **ENT**  key, **P4.2 TIME** screen appears. This indicates completion of the time setup.

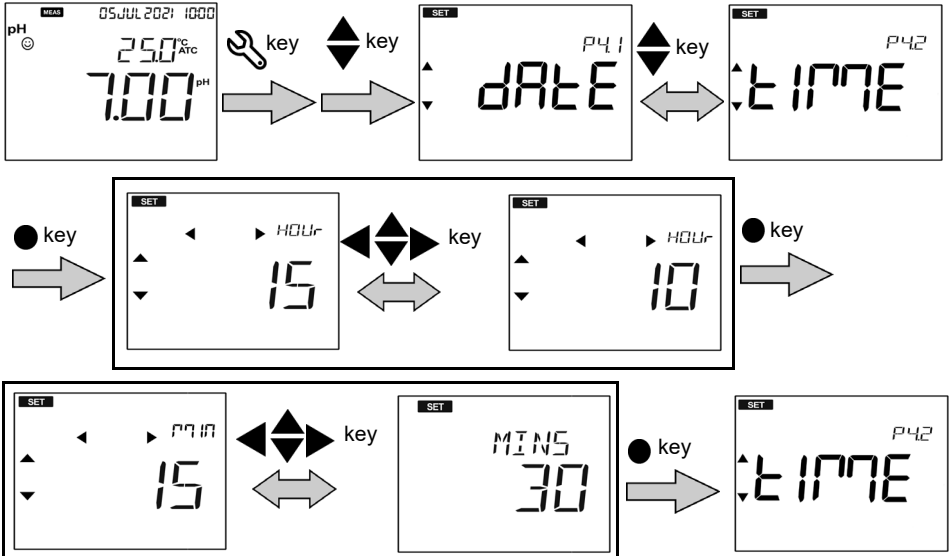

■ Maintenance and Storage

This section describes maintenance and storage of the instrument and the electrodes that are used with the instrument. To use them for a long period, perform the described maintenance procedures appropriately.

● Contact for Maintenance

Please contact your dealer for the product maintenance.

● Maintenance and Storage of the Instrument

- If the instrument is dirty, wipe it gently with a soft dry cloth. If it is difficult to remove the dirt, wipe it gently with a cloth moistened with alcohol.
- The instrument is made of solvent resistant materials but is not resistant to all chemicals. Do not dip the instrument in strong acid or alkali solution, or wipe it with such solutions.
- Do not wipe the instrument with polishing powder or other abrasive compound.

● Environmental Conditions for Storage

- Temperature: 0°C to 45°C
- Humidity: under 80% relative humidity and free from condensation

Avoid the following conditions:

- Dusty place
- Strong vibration
- Direct sunlight
- Corrosive gas environment
- Close to an air-conditioner
- Direct wind

• Maintenance and Storage of Electrodes

This section describes an overview of the procedures for maintenance and storage of pH, ORP, ion and DO electrodes. For the detailed procedures, refer to the instruction manual for each electrode.

• How to clean the electrodes

When the tip of an electrode (responsive membrane and liquid junction) becomes dirty, the response time may slow or an error may occur in the measurement results. To avoid such errors, clean the electrode. For dirt that cannot be washed off by pure water (or deionized water), use the cleaning solution indicated below depending on the type of dirt. After cleaning, rinse the electrode with pure water (or deionized water).

However for pH and ORP electrodes, different cleaning solutions should be used to clean different types of dirt.

For pH Electrode

| Type of dirt | Cleaning solution |
|---------------------|---|
| General | Diluted neutral cleaning solution |
| Oil | Alcohol, or diluted neutral cleaning solution |
| Inorganic substance | 1 mol/L HCl or electrode cleaning solution (model 220) |
| Protein | Cleaning solution including protein-removing enzyme (model 250) |
| Alkaline | Dip in 1 mol/L HCl or electrode cleaning solution (model 220) for 1h to 2 h |

For ORP Electrode

| Type of dirt | Cleaning solution |
|---------------------|--|
| General | Dilute neutral cleaning solution (General dishwashing liquid works reasonably well.) |
| Oil | |
| Inorganic substance | Immerse dilute nitric acid (1:1 nitric acid) |

How to clean the membrane of DO electrode

- If the electrode membrane is dirty, clean it by using a soft cloth, taking care not to scratch the membrane. Then, rinse the membrane with tap water.
- If an error occurs during calibration, replace the DO tip.

• Daily storage of pH and ORP electrodes

If the electrode becomes dry, the response will be slow. Store in a moist atmosphere. Follow the steps below to properly store the electrode:

1. Wash the electrode well with pure water (or deionized water) to remove sample completely, and close the internal solution filler port.
2. Wash the inside of the protective cap with pure water (or deionized water), then add enough pure water (or deionized water) to soak the sponge.
3. Attach the protective cap.

Note

- When the electrode will not be used for a long period, store it by following the electrode storage procedure detailed above.
- For long-term storage of pH and ORP electrodes, replace the reference electrode internal solution with new solution once every 3 to 6 months.

• Daily storage of Ion Electrode

For the detailed procedures for maintaining and storing electrodes, refer to the instruction manual for each electrode. While the electrode is stored, the concentration of the reference internal solution (outer tube) may change. For this reason, replace the reference internal solution (outer tube) with a dropper or similar tool about once a week to once a month. For conditioning the ion electrodes, refer to the table below:

| Ion | Conditioning Solution |
|---|--|
| Ammonia (NH ₃) | Soak the electrode (with membrane cap attached) in a beaker containing filling solution for at least 15 minutes. |
| Calcium (Ca ²⁺) | Soak in 100mg/L (or higher) standard with or without ISA for at least 1 hr. |
| Chloride (Cl ⁻) | Soak in 100mg/L (or higher) standard with or without ISA for at least 1 hr. |
| Fluoride (F ⁻) | Soak the electrode in 100mg/L or higher without TISAB for at least 1 hr. |
| Nitrate (NO ₃ ⁻) | Soak in 100mg/L (or higher) standard with or without ISA for at least 1 hr. |
| Potassium (K ⁺) | Soak in 100mg/L (or higher) standard with or without ISA for at least 1 hr. |

Note

For long-term storage of ion electrode, remove the electrode tip and put the rubber cap. Put the protective cap on the electrode. Be sure to keep the protective cap dry. Store both the electrode tip and the electrode in a dry place. Before reuse, condition the electrode.

• Daily storage of DO Electrode

The electrode should remain connected to the meter. To store the electrode without the meter, follow the below procedure.

1. Remove the electrode from the connector on the meter.

2. Wash the electrode well with tap water, then dry it with soft cloth.

3. Remove the DO tip from the electrode body.

4. Put the short socket onto the DO tip, then store it in a cool, dark location with an oxygen scavenger.

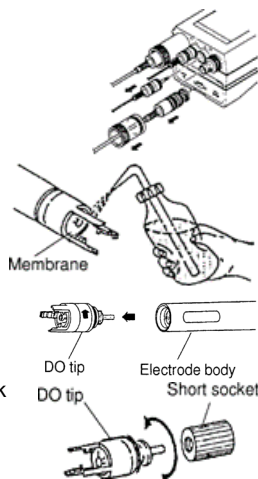

Note

Avoid storing the electrode in hot places with high humidity. Store the electrode indoors, out of direct sunlight.

• Maintenance of the DO electrode

1. After finishing measurement, wash the DO electrode well with tap water.

2. Keep the electrode immersed in tap water. Leave the electrode connected to the meter.

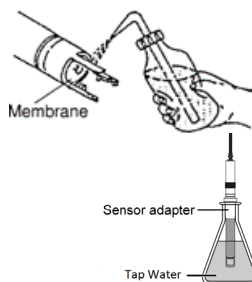

Note



If the electrode is stored for a long period of time without being connected to the meter, it may be difficult to stabilize the reading during measurements.

■ Error Messages and Troubleshooting

● Error Messages

This section describes the causes of typical errors and the actions to be taken to resolve respective errors. Check these before contacting us.

If ERR is displayed while you are using the instrument, refer to the table below:

| Error | Definition | Cause and Solution |
|---|---------------------------------|---|
| OFFS ERR | Offset voltage error | Electrode is dirty or reference junction is clogged. Clean the electrode. |
| SLPE ERR | Slope error | Electrode sensitivity is low. Please clean and recalibrate with fresh standard solution. If the problem persists, replace the electrode with new one. |
| BUFF ERR | Cannot auto recognize pH buffer | The instrument cannot identify the pH buffer. Check the calibration solution and use fresh one if required. |
| DATA FULL | Memory data full | The maximum number of saved data has been exceeded. Print or transfer all data then perform data log clear. |
|  | Invalid Operation | Invalid button operation or the input value is out of range. Check the procedure in this manual before operating. |
| CAL DUE (Electrode icon blinks in MEAS mode) | Calibration past due | Calibration was not performed at the designated interval - the set number of days in calibration alarm setup has passed. Perform calibration. |
| NOT STBLE | Not stable | ENT  key is pressed before the smiley icon and calibration value have stabilized. Wait for smiley icon and calibration value to stabilize before pressing ENT  key. |
| HIGH OFFS | High offset | Appears when input temperature is below/above 10°C from original value during temperature calibration. |

Error Messages and Troubleshooting

| Error | Definition | Cause and Solution |
|-------------------|----------------------------|--|
| UNDR RANGE | Under range | Entered value is outside the setting range. Please confirm the setting range and enter value correctly. |
| OVER RANGE | Over range | |
| CAL LMT | Calibration limit exceeded | The maximum number of calibration points that can be calibrated has been exceeded. Clear the calibration data. |

• Troubleshooting

This section describes causes and actions to take for problems that customers frequently ask.

The indicated value fluctuates

< Problem with the electrode >

| Cause | How to solve problem |
|---|---|
| The electrode is dirty. | Clean the electrode. |
| The electrode is cracked. | Replace the electrode. |
| The wrong internal solution is being used. | Use the correct internal solution. |
| There are air bubbles on the electrode. | Shake the electrode to remove the air bubbles. |
| The level of internal solution in reference electrode is low. | Replenish the internal solution of the reference electrode until it is higher than the level of the sample. |

< Problem with the instrument >

| Cause | How to solve problem |
|---|---|
| There is a motor or other device causing electrical interference. | Measure at a place where no influence from induction is given. Ground all AC-powered equipment. |
| The electrode is not connected correctly. | Connect the electrode properly. |

< Problem with the sample >

| Cause | How to solve problem |
|--|---|
| Electrode is not immersed enough to cover liquid junction. | The electrode must be immersed up to the liquid junction. As a guide, immerse to at least 3 cm from the tip of the electrode. |
| The stability of electrode is affected by the sample solution. | It is important to select an electrode that is appropriate for the sample. Consult your dealer. To confirm an electrode that is appropriate for the sample, check the pH electrode selection guide in our catalogue, or refer to our website. |

The response is slow

| Cause | How to solve problem |
|---|---|
| The electrode is dirty. | Clean the electrode. |
| The electrode is broken. | Replace the electrode. |
| The response of electrode is affected by the sample solution. | It is important to select an electrode that is appropriate for the sample. Consult your dealer. To confirm an electrode that is appropriate for the sample, check the pH electrode selection guide in our catalogue, or refer to our website. |

The indicated value does not change

| Cause | How to solve problem |
|---|----------------------------------|
| The electrode is cracked. | Replace the electrode. |
| The electrode is not connected correctly. | Connect the electrode correctly. |
| The instrument is in HOLD state. | Cancel the HOLD state. |
| Instrument defect. | Consult your dealer. |

The measured value is out of the measurement range

When the measured value is below the display range, "Ur" appears. When the measured value is over the display range, "Or" appears.

| Cause | How to solve problem |
|---|--|
| Sample is out of the measurement range. | Use a sample within the measurement range. |

Error Messages and Troubleshooting

| Cause | How to solve problem |
|--|--|
| Electrode is not immersed enough to cover liquid junction. | The electrode must be immersed up to the liquid junction. As a guide, immerse to at least 3 cm from the tip of the electrode. |
| The electrode cable is broken. | Replace the electrode. |
| Calibration is not performed or performed incorrectly. | Perform calibration correctly. |
| Instrument defect. | Check as explained below. |

• How to check for instrument defect

Short the metal part of the outer tube to the center pin of the electrode connector of the corresponding channel of the instrument. If the measured value blinks or does not show zero, consult your dealer.

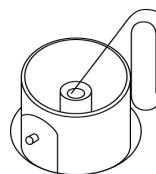

Repeatability of the measured value is poor

| Cause | How to solve problem |
|--|---|
| Effect of the sample solution. | Repeatability becomes poor when the pH of the sample changes over time. |
| The electrode is dirty. | Clean the electrode. |
| The electrode is broken. | Replace the electrode. |
| The internal solution of the electrode runs out or contaminated. | Replace the internal solution with new one. |
| The level of internal solution in reference electrode is low. | Replenish the internal solution of the reference electrode until it is higher than the level of the sample. |

Nothing appears when the power is turned ON

| Cause | How to solve problem |
|------------------------|-------------------------|
| Instrument defect. | Consult your dealer. |
| Power is not supplied. | Connect the AC adapter. |

Swelling of keypad

| Cause | How to solve problem |
|--|--|
| Using the instrument at high elevation or other location where the air pressure is different from sea level. | To eliminate the pressure difference between the inside and outside of the instrument, briefly open and then close the serial connector cover. After opening, correctly close the cover to maintain dust and water proofing. |
| Instrument defect. | Consult your dealer. |

Part of the display is missing

| Cause | How to solve problem |
|--------------------|---|
| Instrument defect. | Check the display by switching ON the instrument when all the LCD segments are lit. |

■ Appendix

This section describes the technical information, printer formats, and specifications of the instrument.

● Appendix 1

pH calibration can be performed according to several buffer standards. The most common standard is the US buffer standard. The default setup is US buffer standard. Alternative standards that can be chosen are NIST, NIST2, DIN and CUST (Custom).

The pH buffers are temperature dependent i.e. the pH value changes with change in temperature. The meter is intelligent to detect the temperature and pH value associated with buffer when calibration is performed. It remembers all the temperature vs. pH value for all the standards.

The pH vs. temperature values for the various standards are listed below:

< USA >

| Temp. (°C) | pH 1.68 | pH 4.01 | pH 7.00 | pH 10.01 | pH 12.46 |
|------------|---------|---------|---------|----------|----------|
| 0 | 1.67 | 4.01 | 7.12 | 10.32 | 13.42 |
| 5 | 1.67 | 4.01 | 7.09 | 10.25 | 13.21 |
| 10 | 1.67 | 4.00 | 7.06 | 10.18 | 13.00 |
| 15 | 1.67 | 4.00 | 7.04 | 10.12 | 12.81 |
| 20 | 1.68 | 4.00 | 7.02 | 10.06 | 12.63 |
| 25 | 1.68 | 4.01 | 7.00 | 10.01 | 12.45 |
| 30 | 1.69 | 4.01 | 6.99 | 9.97 | 12.29 |
| 35 | 1.69 | 4.02 | 6.98 | 9.93 | 12.13 |
| 40 | 1.70 | 4.03 | 6.97 | 9.89 | 11.98 |
| 45 | 1.70 | 4.04 | 6.97 | 9.86 | 11.84 |
| 50 | 1.71 | 4.06 | 6.97 | 9.83 | 11.70 |
| 55 | 1.72 | 4.08 | 6.97 | 9.81 | 11.57 |

< NIST >

| Temp. (°C) | pH 1.68 | pH 4.01 | pH 6.86 | pH 9.18 | pH 12.46 |
|------------|---------|---------|---------|---------|----------|
| 0 | 1.67 | 4.01 | 6.98 | 9.46 | 13.42 |
| 5 | 1.67 | 4.01 | 6.95 | 9.39 | 13.21 |
| 10 | 1.67 | 4.00 | 6.92 | 9.33 | 13.00 |
| 15 | 1.67 | 4.00 | 6.90 | 9.27 | 12.81 |
| 20 | 1.68 | 4.00 | 6.88 | 9.22 | 12.63 |
| 25 | 1.68 | 4.01 | 6.86 | 9.18 | 12.45 |
| 30 | 1.69 | 4.01 | 6.85 | 9.14 | 12.29 |
| 35 | 1.69 | 4.02 | 6.84 | 9.10 | 12.13 |
| 40 | 1.70 | 4.03 | 6.84 | 9.07 | 11.98 |
| 45 | 1.70 | 4.04 | 6.83 | 9.04 | 11.84 |
| 50 | 1.71 | 4.06 | 6.83 | 9.01 | 11.70 |
| 55 | 1.72 | 4.08 | 6.83 | 8.99 | 11.57 |

< NIST2 >

| Temp. (°C) | pH 1.68 | pH 4.01 | pH 6.86 | pH 10.01 | pH 12.46 |
|------------|---------|---------|---------|----------|----------|
| 0 | 1.67 | 4.01 | 6.98 | 10.32 | 13.42 |
| 5 | 1.67 | 4.01 | 6.95 | 10.25 | 13.21 |
| 10 | 1.67 | 4.00 | 6.92 | 10.18 | 13.00 |
| 15 | 1.67 | 4.00 | 6.90 | 10.12 | 12.81 |
| 20 | 1.68 | 4.00 | 6.88 | 10.06 | 12.63 |
| 25 | 1.68 | 4.01 | 6.86 | 10.01 | 12.45 |
| 30 | 1.69 | 4.01 | 6.85 | 9.97 | 12.29 |
| 35 | 1.69 | 4.02 | 6.84 | 9.93 | 12.13 |
| 40 | 1.70 | 4.03 | 6.84 | 9.89 | 11.98 |
| 45 | 1.70 | 4.04 | 6.83 | 9.86 | 11.84 |
| 50 | 1.71 | 4.06 | 6.83 | 9.83 | 11.70 |
| 55 | 1.72 | 4.08 | 6.83 | 9.81 | 11.57 |

< DIN >

| Temp. (°C) | pH 1.09 | pH 3.06 | pH 4.65 | pH 6.79 | pH 9.23 | pH 12.75 |
|------------|---------|---------|---------|---------|---------|----------|
| 0 | 1.08 | 3.10 | 4.67 | 6.89 | 9.48 | 13.37 |
| 5 | 1.09 | 3.10 | 4.66 | 6.87 | 9.43 | 13.37 |
| 10 | 1.09 | 3.10 | 4.66 | 6.84 | 9.37 | 13.37 |
| 15 | 1.09 | 3.08 | 4.65 | 6.82 | 9.32 | 13.17 |
| 20 | 1.09 | 3.07 | 4.65 | 6.80 | 9.27 | 12.96 |
| 25 | 1.09 | 3.06 | 4.65 | 6.79 | 9.23 | 12.75 |
| 30 | 1.10 | 3.05 | 4.65 | 6.78 | 9.18 | 12.61 |
| 35 | 1.10 | 3.04 | 4.65 | 6.77 | 9.13 | 12.45 |
| 40 | 1.10 | 3.04 | 4.66 | 6.76 | 9.09 | 12.29 |
| 45 | 1.11 | 3.04 | 4.67 | 6.76 | 9.04 | 12.14 |
| 50 | 1.11 | 3.04 | 4.68 | 6.76 | 9.00 | 11.98 |
| 55 | 1.11 | 3.04 | 4.69 | 6.76 | 8.96 | 11.84 |

Note

Calibration is performed using Nernst's equation with the above values.

Saturated DO levels in water at various temperatures

ISO17289 (JIS K0102)

| Temp. (°C) | Saturated DO (mg/L) | Temp. (°C) | Saturated DO (mg/L) | Temp. (°C) | Saturated DO (mg/L) | Temp. (°C) | Saturated DO (mg/L) |
|------------|---------------------|------------|---------------------|------------|---------------------|------------|---------------------|
| 1 | 14.22 | 11 | 11.03 | 21 | 8.92 | 31 | 7.43 |
| 2 | 13.83 | 12 | 10.78 | 22 | 8.74 | 32 | 7.31 |
| 3 | 13.46 | 13 | 10.54 | 23 | 8.58 | 33 | 7.18 |
| 4 | 13.11 | 14 | 10.31 | 24 | 8.42 | 34 | 7.07 |
| 5 | 12.77 | 15 | 10.08 | 25 | 8.26 | 35 | 6.95 |
| 6 | 12.45 | 16 | 9.87 | 26 | 8.11 | 36 | 6.84 |
| 7 | 12.14 | 17 | 9.67 | 27 | 7.97 | 37 | 6.73 |
| 8 | 11.84 | 18 | 9.47 | 28 | 7.83 | 38 | 6.62 |
| 9 | 11.56 | 19 | 9.28 | 29 | 7.69 | 39 | 6.52 |
| 10 | 11.29 | 20 | 9.09 | 30 | 7.56 | 40 | 6.41 |

BOD Computation

A. Without Seed Correction

$$\text{BOD}_5, \text{ mg/L} = \frac{(D_1 - D_2) V_B}{V_S}$$

where:

D₁ = DO of diluted sample immediately after preparation, mg/L,

D₂ = DO of diluted sample after 5-day incubation at 20°C, mg/L,

V_B = volume of the respective test bottle, mL, and

V_S = volume of sample in the respective test bottle, mL

B. With Seed Correction

$$\text{BOD}_5, \text{ mg/L} = \frac{[(D_1 - D_2) - S_c] V_B}{V_S}$$

where:

D₁ = DO of diluted sample immediately after preparation, mg/L,

D₂ = DO of diluted sample after 5-day incubation at 20°C, mg/L,

V_B = volume of the respective test bottle, mL,

V_S = volume of sample in the respective test bottle, mL, and

S_c = seed correction, mg/L, calculated from

[seed BOD, mg/L x (seed volume, mL / bottle volume, mL)]

- Appendix 2

Printer Format - Measurement

pH

| HORIBA | |
|-----------|--------------|
| Model | PD2000 |
| S/No | A82C1234 |
| SW Rev | 1.00 |
| Date | 08MAR2022 |
| Time | 09:41:48 |
| Mode | pH |
| Stability | STABLE |
| pH | 4.21 pH |
| mV | 151.4 mV |
| Temp. | 23.7 C (ATC) |
| Electrode | EXCELLENT |
| User Name | |
| Signature | |

mV

| HORIBA | |
|-----------|--------------|
| Model | PD2000 |
| S/No | A82C1234 |
| SW Rev | 1.00 |
| Date | 08MAR2022 |
| Time | 09:41:48 |
| Mode | mV |
| Stability | STABLE |
| mV | 151.4 mV |
| Temp. | 23.7 C (ATC) |
| User Name | |
| Signature | |

Relative mV

| HORIBA | |
|-----------|--------------|
| Model | PD2000 |
| S/No | A82C1234 |
| SW Rev | 1.00 |
| Date | 08MAR2022 |
| Time | 09:41:48 |
| Mode | R.mV |
| Stability | STABLE |
| R.mV | 147.8 R.mV |
| Offset | -3.4 mV |
| Temp. | 24.1 C (ATC) |
| User Name | |
| Signature | |

Ion

| HORIBA | |
|-----------|--------------|
| Model | PD2000 |
| S/No | A82C1234 |
| SW Rev | 1.00 |
| Date | 08MAR2022 |
| Time | 12:20:37 |
| Mode | ION |
| Stability | STABLE |
| ION | 0.102 g/L |
| mV | -17.6 mV |
| Temp. | 25.0 C (MAN) |
| Electrode | EXCELLENT |
| User Name | |
| Signature | |

DO (%)

| HORIBA | |
|-----------|--------------|
| Model | PD2000 |
| S/No | A82C1234 |
| SW Rev | 1.00 |
| Date | 08MAR2022 |
| Time | 17:41:11 |
| Mode | DO |
| Stability | STABLE |
| DO | 100.0 %Sat |
| Temp. | 25.0 C (ATC) |
| Salinity | 0.0 ppt |
| Pressure | 101.3 kPa |
| Electrode | EXCELLENT |
| User Name | |
| Signature | |

DO (mg/L)

| HORIBA | |
|-----------|--------------|
| Model | PD2000 |
| S/No | A82C1234 |
| SW Rev | 1.00 |
| Date | 08MAR2022 |
| Time | 17:41:11 |
| Mode | DO |
| Stability | STABLE |
| DO | 8.26 mg/L |
| Temp. | 25.0 C (ATC) |
| Salinity | 0.0 ppt |
| Pressure | 101.3 kPa |
| Electrode | EXCELLENT |
| User Name | |
| Signature | |

BOD

| HORIBA | |
|--------------|-------------------------|
| Model | PD2000 |
| S/No | A82C1234 |
| SW Rev | 1.00 |
| BOD Result | |
| BOD Start | 09APR2022 09: 00: 00 |
| BOD End | 14APR2022 09: 00: 00 |
| Sample BOD | 11.76 mg/L |
| Initl. DO | 8.08 mg/L |
| Initl. Temp. | 20.0 C (ATC) |
| End DO | 2.50 mg/L |
| End Temp. | 20.0 C (ATC) |
| Sample Vol. | 100.0 mL |
| Bottle Vol. | 300.0 mL |
| Samp. Min DO | 2.00 mg/L |
| Seed Vol. | 10.00 mL |
| Seed BOD | 50.00 mg/L |
| User Name | |
| Signature | |

Printer Format - Data Log

| HORIBA | |
|-------------|--------------|
| Model | PD2000 |
| S/No | A82C1234 |
| SW Rev | 1.00 |
| User Name | |
| Signature | |
| Logged Data | |
| Location | 5 |
| Date | 09MAR2022 |
| Time | 10:44:36 |
| Mode | DO |
| Stability | STABLE |
| DO | 100.0 %Sat |
| Temp. | 25.0 C (ATC) |
| Salinity | 0.0 ppt |
| Pressure | 101.3 kPa |
| Electrode | EXCELLENT |
| Location | 4 |
| Date | 23FEB2022 |
| Time | 12:23:39 |
| Mode | ION |
| Stability | STABLE |
| ION | 0.102 g/L |
| mV | -17.6 mV |
| Temp. | 25.0 C (MAN) |
| Electrode | EXCELLENT |
| Location | 3 |
| Date | 23FEB2022 |
| Time | 11:28:13 |
| Mode | pH |
| Stability | STABLE |
| pH | 4.03 pH |
| mV | 162.3 mV |
| Temp. | 23.8 C (ATC) |
| Electrode | EXCELLENT |
| Location | 2 |
| Date | 23FEB2022 |
| Time | 10:38:24 |
| Mode | R.mV |
| Stability | STABLE |
| R.mV | 750.3 R.mV |
| Offset | -3.4 mV |
| Temp. | 23.8 C (ATC) |
| Location | 1 |
| Date | 22FEB2022 |
| Time | 10:00:46 |
| Mode | mV |
| Stability | STABLE |
| mV | 212.3 mV |
| Temp. | 25.0 C (MAN) |

Printer Format - Calibration

pH

| HORIBA | | |
|------------------|--------------|-------|
| Model | PD2000 | |
| S/No | A82C1234 | |
| SW Rev | 1.00 | |
| Date | 08MAR2022 | |
| Time | 09:41:48 | |
| Calibration Data | | |
| Cal Date | 07MAR2022 | |
| Cal Time | 12:29:58 | |
| Cal Points: | | |
| pH | mV | Slope |
| 4.01 | 163.2 | 98.9% |
| 7.00 | -11.3 | 98.1% |
| 10.01 | -185.7 | |
| Offset | -11.0 mV | |
| Avg Slope | 98.5% | |
| Temp. | 23.3 C (ATC) | |
| Electrode | EXCELLENT | |
| User Name | | |
| Signature | | |

Ion

| HORIBA | | |
|------------------|--------------|-------|
| Model | PD2000 | |
| S/No | A82C1234 | |
| SW Rev | 1.00 | |
| Date | 08MAR2022 | |
| Time | 12:25:49 | |
| Calibration Data | | |
| Cal Date | 07MAR2022 | |
| Cal Time | 17:32:01 | |
| Cal Points: | | |
| Ion Value | mV | Slope |
| 0.100 g/L | -17.2 | 98.4% |
| 1.000 g/L | -75.4 | |
| Avg Slope | 98.4% | |
| Cal. Temp. | 25.0 C (MAN) | |
| Electrode | EXCELLENT | |
| User Name | | |
| Signature | | |

DO (%)

| HORIBA | |
|------------------|--------------|
| Model | PD2000 |
| S/No | A82C1234 |
| SW Rev | 1.00 |
| Date | 09MAR2022 |
| Time | 09:56:54 |
| Calibration Data | |
| Cal Date | 08MAR2022 |
| Cal Time | 17:40:07 |
| Cal Points: | 100.0% |
| 0.0% | |
| Span.Coef | 1.179 |
| Zero.Coef | 0.040 |
| Temp. | 22.9 C (ATC) |
| Pressure | 101.3 kPa |
| Salinity | 0.0 ppt |
| Electrode | EXCELLENT |
| User Name | |
| Signature | |

DO (mg/L)

| HORIBA | |
|------------------|--------------|
| Model | PD2000 |
| S/No | A82C1234 |
| SW Rev | 1.00 |
| Date | 09MAR2022 |
| Time | 09:56:54 |
| Calibration Data | |
| Cal Date | 08MAR2022 |
| Cal Time | 17:40:07 |
| Cal Points: | 8.26 mg/L |
| 0.00 mg/L | |
| Span.Coef | 1.165 |
| Zero.Coef | 0.000 |
| Temp. | 22.9 C (ATC) |
| Pressure | 101.3 kPa |
| Salinity | 0.0 ppt |
| Electrode | EXCELLENT |
| User Name | |
| Signature | |

• Meter Specifications

| Specifications | LAQUA-DO2000 DO/BOD/Temp (°C/°F) LAQUA-PD2000 pH/ORP/Ion/DO/BOD/Temp (°C/°F) |
|---|---|
| pH Range | -2.000 to 20.000 pH |
| Resolution | 0.1 / 0.01 / 0.001 pH |
| Accuracy | ± 0.003 pH |
| pH Buffer Groups | USA, NIST, NIST2, DIN, Custom |
| Calibration Points | Up to 5 (USA, NIST, NIST2) / Up to 6 (DIN, Custom) |
| ORP Range | ± 2000.0 mV |
| Resolution | 0.1 mV |
| Accuracy | ±0.2 mV |
| Calibration Option | Yes (Up to ±200 mV) |
| Ion Range | 0.000 µg/L to 9999 g/L |
| Units | µg/L ↔ mg/L ↔ g/L, ppm ↔ ppt, mmol/L ↔ mol/L |
| Resolution | 4 Significant digits |
| Accuracy | ± 0.3% full scale or ± 0.2 mV, whichever is higher |
| Calibration Points | Up to 5 |
| DO Range | 0.0 to 60.00 mg/L, 0.0 to 600.0% |
| Resolution | 0.01 mg/L, 0.1% |
| Accuracy | +/- 0.1 mg/L, +/- 1.0% |
| Salinity Compensation | 0.0 to 40.0 ppt |
| Barometric Pressure Compensation | 10.0 to 200.0 kPa |
| BOD Measurement | 5-day BOD with seed correction |
| DO Probe Type | Galvanic integrated with temperature sensor |
| Calibration Points | Up to 2 |
| Temperature Range | -30.0 to 130.0 °C / -22.0 to 266.0 °F |
| Resolution | 0.1 °C / °F |
| Accuracy | ± 0.5 °C / ± 0.9 °F |
| Calibration Option | Yes (± 10.0 °C / ± 18.0 °F range in 0.1 °C increment) |

Meter Specifications

| Specifications | LAQUA-DO2000 DO/BOD/Temp (°C/°F) LAQUA-PD2000 pH/ORP/Ion/DO/BOD/Temp (°C/°F) |
|-----------------------------------|--|
| Memory | 2000 data sets |
| Auto Data Log | Yes |
| Real-time Clock | Yes |
| Date & Time Stamp | Yes |
| Measurement Modes | Auto Stable / Auto Hold / Real Time |
| Offset & Slope Display | Yes (Segment & Average Slopes) |
| Calibration Alarm | Yes (Programmable: up to 90 days) |
| Auto Shut-Off | Yes (Programmable: up to 30 mins.) |
| Electrode Status | On screen display |
| Diagnostics | Yes |
| Password Setting | Yes |
| Software Upgrade | Yes |
| PC / Printer Communication | Phono jack (USB / RS232) |
| Meter Inputs | LAQUA-DO2000: BNC, phono (ATC), DC sockets LAQUA-PD2000: 2 x BNC, 2 x phono (ATC), DC sockets |
| Display | 5" Custom LCD with 320 segments and backlight |
| Power Rating AC Adapter | Input Voltage: 100 - 240VAC +/-10%, 50/60Hz |
| Power Rating Instrument | Input Voltage: 7V |
| | Power Consumption: 0.7 W / 100 mA |
| Dimensions | 155 (L) x 150 (W) x 67 (H) mm |
| Weight | LAQUA-DO2000: approx. 765g LAQUA-PD2000: approx. 770g |
| Electrode Stand | Integrated |
| Warranty | 3 years |

HORIBAAdvanced Techno

2 Miyanohigashi-cho, Kisshoin, Minami-ku, Kyoto, 601-8551, Japan
<http://www.horiba-adt.jp>

For any questions regarding this product, please contact your local agency, or inquire from the following website.
http://global.horiba.com/contact_e/index.htm

Local: M004374
P/N: 3200947008
GZ: 0000671681